



DESROCHERS

CUIRS · LEATHERS

— 1981 —



Catalogue
quincaillerie et
outils
*Hardware and tools
Catalog*

2^e édition bilingue / *Bilingual 2nd edition*
rev. Février/February 2022



1857, rue Savoie, Plessisville (Québec) G6L 1L1 • 819-362-8622 • 1-800-362-8622

www.cuirsdessrochers.com • [cuirdessrochers@cuirdessrochers.com](mailto:cuirsdessrochers@cuirdessrochers.com)



DESROCHERS

CUIRS · LEATHERS

— 1981 —

L'expertise du cuir transmise de génération en génération
Leather Know-how Passed Down Through Generations



Cuir Desrochers est un grossiste reconnu pour son vaste choix de peaux de cuir et de suède et un fabricant d'une grande variété d'articles de cuir. Nous distribuons une large gamme d'outils de travail du cuir et de quincaillerie. Depuis près de 40 ans, notre entreprise familiale québécoise sert les designers, les maroquiniers, les cordonniers, les artisans, les travailleurs et les entrepreneurs. Notre équipe écoute attentivement les besoins de nos clients et propose des conseils appuyés d'une connaissance experte du matériau de cuir. / *As a trusted wholesaler, Desrochers' Leathers offers a wide selection of leather and suede skins. We also manufacture classic leather goods and distribute a vast array of leatherworking tools and hardware. For over 40 years, our family-owned business has served and continues to serve many designers, cobblers, crafters, workers and entrepreneurs. Truly in tune to our clients' needs, our team offers expert advice based on a deep understanding of leather materials.*

Commander chez Cuir Desrochers, c'est facile! / Order at Desrochers Leathers, it's easy!

Chez Cuir Desrochers, la satisfaction de notre clientèle passe avant tout. Notre équipe saura répondre à toutes vos questions et à vos demandes avec précision. / *At Desrochers Leathers, the satisfaction of our customers comes first. Our team will answer all your questions and requests with precision.*

Choisissez
Choose

Commandez
Order

Recevez
Receive



Parlez à de vrais spécialistes, nous sommes toujours là pour vous.

Talk to real specialists, we are always here for you.

3 façons simples de commander! / 3 easy ways to order!

Par téléphone au/ *By phone* **1 800 362-8622, # 1**

Par courriel à/ *by email* : commande@cuirsdesrochers.com.

Boutique en ligne (cuirs et articles fait en cuir seulement)/ *Online Store (leather and articles made of leather only)* <https://boutique.cuirsdesrochers.com>

Peu importe la façon de commander, votre achat sera emballé avec soin et vous sera acheminé rapidement. / *No matter how you order, your purchase will be carefully packed and shipped to you quickly.*

Vous aimeriez voir et toucher nos cuirs avant achat?

Do you want to see and touch our leathers before buying it?

N'hésitez pas à nous contacter **1 800 362-8622**. Il nous fera plaisir de vous accueillir à notre entrepôt (sur rendez-vous). *Contact us 1800 362-8622. It will be our pleasure to welcome you at our boutique/warehouse.*

Visitez le cuirsdesrochers.com pour en SAVOIR et EN VOIR plus!

Visit cuirsdesrochers.com to LEARN and SEE more!



TABLE DES MATIÈRES / TABLE OF CONTENT



Cliquez sur les carrés
/ Clic on squares

<p>Textiles <i>Textile</i></p> <p>4</p>	<p>Fils, lanières et aiguilles <i>Thread, laces and needles</i></p> <p>6</p>	<p>Bandes élastiques, rubans velours et courroies <i>Elastic bands, hook & loop tape and webbing</i></p> <p>12</p>	<p>Fermetures à glissière, curseurs et arrêts <i>Zippers, sliders & stoppers</i></p> <p>14</p>
<p>Mousses et caoutchouc <i>Foam and Rubber</i></p> <p>26</p>	<p>Boutons pression, œillets, rondelles et rivets <i>Snaps fasteners, grommets, washer & rivets</i></p> <p>27</p>	<p>Accessoires en nylon <i>Nylon accessories</i></p> <p>31</p>	<p>Mousquetons <i>Snap hook</i></p> <p>32</p>
<p>Boucles <i>Buckles</i></p> <p>35</p>	<p>Quincaillerie <i>Hardware</i></p> <p>40</p>	<p>Décorations <i>Decorations</i></p> <p>47</p>	<p>Artisanat Premières Nations <i>First Nation Crafts projects</i></p> <p>48</p>
<p>Teinture, adhésifs et entretien du cuir <i>Leather dyeing, adhesives and care</i></p> <p>49</p>	<p>Outils <i>Tools</i></p> <p>58</p>		

Bien que nous nous efforçons de mettre régulièrement ce catalogue à jour, certains produits peuvent différer.
Although we strive to update this catalog regularly, some products may change.



CLARINO

Pour remplacement d'intérieurs de gants de hockey, couvre-renforts, etc. /
To replace hockey glove liners, shoe liners, etc.

Composition / Content : 100% polyester Micro fibre / *Microfiber 100% polyester*

Couleur / Color : noir / *black*

Largeur / Width : 54" (1,37 mètre/metre)



CORDURA 1000

Nylon fort pour confection / *Heavy duty nylon for manufacturing.*

Composition / Content : 100% nylon

Composition de support / Backing support : 100% polyuréthane / *polyurethane, 1000 Denier*

Largeur / Width : 59" (1,49 mètre/metre)

Revêtement protecteur / Protective finish : résistant hydrofuge / *water repellent*

Couleur / Color : noir, blanc / *black, White.* Autre couleur sur demande /

Other color available on request



DUFFLE / FEUTRE (FELT LINER)

Pour isolation et protection (ex.: mocassins) / *For insulation and protection (ex: mocassins).*

Épaisseur / Thickness : 1/8" (3,2mm) ou /or 1/4" (6,4 mm)

Type de fibre / Fiber type : Polyester

Largeur / Width : Duffle : 54" (1,37 mètres / metre) Feutre /Felt 60" (1,52 mètre / metre)

Longueur / Length : 328' (100 mètres / metre)

Type produit / Product type : feutre aiguilleté / *needle felt*

Couleur / Color : Beige (Duffle 1/8") Gris/Grey (Feutre/Felt 1/4")



PLASTIQUE MICA / MICA PLASTIC

Pour abris / *For shelters.*

20GGE AVEC PAPIER / *WITH PAPER*

Composition / Content : 100% chlorure de polyvinyle / (PVC) / *polyvinyl chloride*

Résistance au déchirement au froid / Cold crack : -30 C

Largeur / Width : 54" (1,37 mètres / metre)

30GGE AVEC PAPIER / *WITH PAPER*

Composition / Content : 100% chlorure de polyvinyle / (PVC) / *polyvinyl chloride*

Résistance au déchirement au froid / Cold crack : -20 C

Largeur / Width : 54" (1,37 mètres / metre)



POLARIS

Vinyle anti-dérapant qui s'étire de tous les sens. Pour recouvrement de siège de motoneige /
Anti-slip vinyl that stretches all the sense. To cover snowmobile seats

Contenu de l'endos / Backing content: 100% polyester

Résistance au déchirement au froid / Cold crack : -40C

Résistant à la moisissure / Mildew resistant : oui / *yes*

Largeur / Width : 54" (1,37 mètres / metre)

Couleur / Color : noir/*black*



SNOWSEAT

Pour recouvrement de siège de motoneige / To cover snowmobile seats
Vinyle avec endos poly-coton qui s'étire dans un sens / Vinyl with Poly-Cotton backing, stretches in one way

Résistance au déchirement au froid / Cold crack : -40C

Couleur / Color : Noir seulement / black only

Épaisseur / Thickness : ± 1.22 mm

Largeur / Width : 54" (1,37 mètre/metre)



SPORTLIGHT

Nylon imperméable pour confection/ Water resistant nylon for manufacturing.

Composition/ Content : 100% Nylon , 420 Denier

Largeur / Width: 58" (1,47 mètre/metre)

Résistance au déchirement au froid / Cold crack : -20C

Revêtement arrière / Back coating : chlorure de polyvinyle / polyvinyl chloride

Couleur / Color : noir, marine / black, navy



VINTEX / VINTEX

Toile de PVC, 18 oz. Pour bâches, couvre-piscine, abris temporaires / 18 oz Coated PVC.
For tarpaulins, swimming pool covers, temporary shelters

Composition/ Content : 100% chlorure de polyvinyle / 100% polyvinyl chloride

Fil taille / yarn size : 1000 X 1300 Denier

Résistance au déchirement au froid / Cold crack : -40C

Résistant à la moisissure / Mildew resistant : oui / yes

Largeur / Width : 61" (1,54 mètre/metre)

Couleur / Color : noir, bleu royal, rouge, gris et blanc / black, royal blue, red, grey and white

Autres couleurs disponibles sur commande / other colors available on request.

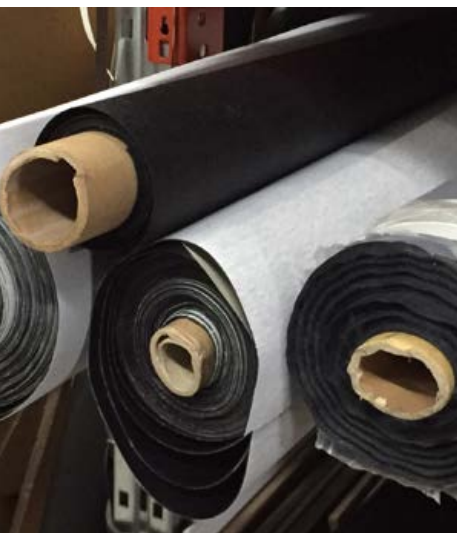



FILS/THREADS #CBB69

Tous ces fils de nylon sont vendus en petites bobines de 300 mètres. / All of our CBB69 small spools contains 300 meters.

Les teintes montrées ci-dessous peuvent varier d'un écran à l'autre et offre un aperçu / Real colors may vary from the images shown below.

Couleurs Colours	Nouveau code couleur New color code	Ancien code couleur /Old color number	Nom Couleur Name of color
	6116	10221	Jaune / Yellow
	6152	51	Rouge Clair / Clear red
	6158	S0538	Rouge foncé / Dark red
	6163	64	Bordeaux
	6183		Bleu gris / Grey blue
	6200	1472	Rose perle / Soft pink
	6208	35845	Rose / Pink
	6251	5071	Fushia
	6257	107	Rouge / Red
	6261	63	Bourgogne / Burgundy
	6263	11254	Raisin / Grapes
	6312	7007	Violet / Purple
	6367	35	Bleu royal / Royal blue
	6370	S500	Bleu royal / Royal blue
	6394	35834	Bleu marin / Navy blue
	6415	6415	Bleu foncé / Dark blue
	6426	CT-0724	Turquoise
	6480	26	Bleu aqua / Aqua blue
	6515	21	Vert jade / Jade green
	6520	S13699	Vert Kelly / Kelly green
	6523	5495	Vert / Green
	6531	S5022	Vert forêt / Forest green
	6567	OG-107	Kaki / Khaki
	6576	2	Vert sauge / Sage green
	6603	71	Blanc cassé / Offwhite
	6610	56	Tortillas
	6613	1803	Gris / Grey
	6614	73	Beige
	6618	53	Vert mousse / Moss green
	6653	74	Tan
	6658	34765	Tan doré / Gold tan
	6661	57	Beige
	6665	54	Beige Cendre / Ash beige
	6673	22	Vert sauge / Sage green
	6677	62	Café / Coffee
	6679	S13802	Taupe
	6711	85	Doré / Gold
	6714	3083	Gingembre / Ginger

Couleurs Colours	Nouveau code couleur New color code	Ancien code couleur /Old color number	Nom Couleur Name of color
	6728	3025	Orange
	6729	347	Caramel / Butterscoth
	6758	12391	Rouille / Rust
	6767	61	Moka
	6781	86	Brun moyen / Medium Brown
	6801	65	Taupe / Taupe
	6806	82	Brun / Brown
	6811	87	Chocolat / Chocolate
	6813	1694	Espresso / Espresso
	6820	66	Gris pâle / Pale grey
	6823	68	Bleu pâle / Pale blue
	6831	67	Vert sauge / Sage green
	6855	89	Gris moyen / Medium Grey
	6863	1306	Gris / Grey
	6865		Gris acier / Steel Grey
	6868	90	Bleu gris / Blue grey
	6869		Anthracite / Anthracite
	6870	8965	Gris foncé / Dark Grey
	6873		Charbon / Charcoal
	6879	7144	Aubergine / Eggplant
	6880		Gris foncé / Dark Grey
	Blanc	Blanc	Blanc / White
	FSD408	FSD408	Orange fluo / Orange fluo
	Noir	Noir	Noir / Black
		25	Vert grisâtre / Grey green
		75	Corail / Copper
		76 SWG	Brun rouille / Rust Brown
		81	Taupe
		3187	Champignon / Mushroom
		4135	Maïs
		37504	Prune / Plum
		37313	Raisin / Grapes
		40520	Sable / Sand
		S144	Bleu jeans / Blue jeans



(Les teintes montrées ici peuvent varier d'un écran à l'autre et offre un aperçu / The color is estimated and may vary from one screen to another)

FILS DE NYLON (ANEFIL)

Disponibles en grosses bobines #69, #138, #207, #346, #554 en format de 1 livre. Un enduit protège le fil de se défaire (bonded thread). D'autres teintes sur demande.

- #69 = ± 6000 verges /lbs (±5500m/lbs)
- #138 = ±2900 vg/lbs (±2670m/lbs)
- #207 = ±1785vg/lbs (±1640m/lbs)
- Les #346 et #554 sont disponibles seulement dans le noir ou blanc

OUR NYLON (ANEFIL) threads available by pound in #69, #138 or #207, #346 or #554.

A coating protects the thread from leaking (bonded thread). Other colors on request.

- #69 = ± 6000 yards /lbs (±5500m/lbs)
- #138 = ±2900 yd/lbs (±2670m/lbs)
- #207 = ±1785 yd/lbs (±1640m/lbs)
- #346 and #554 available only in black or white

Couleurs Colours	Code couleur New color code	Nom Couleur	Name of color	CBB69	138	207
	34050	Rouge scarlett	Scarlet	x		x
	34067	Vert olive	Green olive	x		
	34117	Rouille	Rust		x	
	34136	Bois	Wood	x		x
	34140	Brun pâle	Shade 1600	x		
	34177	Marine	Navy	x	x	
	34215	Naturel	Natural	x	x	
	34370	Orange	Orange	x		
	34664	Brun léger	Light beaver	x		
	35048	Rouge	Red	x		
	35070	Cendré	Ash	x		
	35100	Gris chaud	Seal	x	x	x
	35103	Beige mastic	Mastic Beige	x	x	x
	35472	Acajou foncé	Dark Mahogany	x		
	35495	Gris foncé bleuté	ODS-1	x	x	x
	35497	Doré	Gold	x		
	35500	Fumé	Smoke	x		
	35520	Encre bleu	Navy#3	x	x	x
	35557	Brun	Brown	x		
	35634	Taupe	Beaver	x		
	35670	Acier	Steel	x		
	36030	Tan	Tan		x	x
	36048	Chocolat	Chocolate	x		
	36111	Taupe	Taupe	x		
	36135	Brun foncé	Tonka toast	x		
	36188	Sable	Sand	x		
	36195	Nouveau gris	New Grey	x		
	36241	Rouge écarlate	Scarlet	x	x	x
	36279	Violet 7007	Purple 7007	x	x	
	36289	Vert néon 101	Neon green 101	x		
	36341	Rose néon 102	Neon pink 102	x		
	36731	Jaune néon	Neon Yellow	x		
	36911	Bleu Sarcelle	Teal	x		
	67015	Taupe foncé	Coyote Tan	x		
	67025	Vert éternel	Evergreen	x		x
	67046	Ton de rubis	Rubytone	x	x	
	67048	Nickel	Nickel	x	x	x
	67053	Graphite	Graphite	x		
	67058	Beige peau	Pebble beige	x		
	67067	Brun	Toast brown	x		
	67075	Noyer	Walnut	x		
		Noir	Black	x	x	x
		Blanc	White	x	x	x



NOUVEAUTÉ / NEW

Sunstop® par A&E

Le fil de polyester Sunstop® spécialement développé pour l'extérieur (toiles, auvents, tentes, marine, etc), protection contre les rayons UV, la dégradation et la décoloration.

Sunstop® polyester thread, specially developed for outdoor markets (marine, tents, awnings, outdoor living, etc), UVR protection, degradation and discoloration.

#138-sun = ±1350 vg/lbs (±1234m/lbs)

Couleurs stock : noir et blanc, autres teintes sur demande.

Stock color : black and white, other colors on request.

FIL POUR COUTURE À LA MAIN / CARRIAGE HAND SEWING



119800

Fil naturel ciré pour alène Speedy poly /
Waxed polyester thread for Speedy Awl
119800-30 fin/fine (30V)
119800 fin/fine (180V)
119801-30 épais/coarse (30V)
119801 épais/coarse (180V)



23023

Sinew – Ligneux
Fil ciré plat, se sépare bien; point de
rupture : 70 lbs / Flat waxed lace and
separates well; breaking point : 70 lbs

8 oz, 800 pi / 8 oz, 800ft

Autres couleurs sur demande /
Other color on request



1227

Bobine de fil nylon ciré pour couture à la
main. Point de rupture 35lbs (15,9 kg) 25 v.
(22,9 m). /
Spool waxed nylon thread for hand stitching.
Breaking point 35 lbs (15.9 kg). 25 yds.
(22.9 m).

Noir/Black	Blanc/White	Naturel/ Natural	Rouge/ Red	Royal
Brun foncé/ Dark brown	Turquoise	Emeraude/ Emerald	Violet/Purple	

Noir/Black	Brun/Brown	Blanc/White	Blanc cassé/ Egg Shell



11210 +coul

Corde tressée cirée 22,86 m (25 v) /
Tandy waxes braided cord. 25 yds. (22.9 m)

Noir/Black	Blanc/White	Beige	Bleu/Blue
Brun/Brown	Rouge/Red	Rouille/Rust	Multicolore/ Multicolor
Phosphorescent /Glow			



56450

Fil polyester #6 ciré 4 plis (4 oz). 165v :
Waxed polyester thread #6 4 plys (4 oz)
165yd.

Noir/Black	Brun/Brun	Blanc/White



11207

Fil de lin ciré pour alène, (25 v).
Point de rupture: 25 livres.
Waxed flax thread (25 yd).
Breaking point : 25 lbs

Noir/Black	Brun/Brown	Naturel/Natural



NOUVEAU / NEW

RITZA

Pour couture à la main : Fil 0.6mm de
polyester tissé, légèrement ciré et très résis-
tant. Bobine de 50 mètres Ce fil est reconnu
mondialement et fera votre bonheur lors de
la réalisation de votre prochain projet.
Déclinaison de plusieurs teintes éclatantes.
For hand sewing: 0.6mm woven polyester
thread, lightly waxed and very resistant.
Spools of 50 meters This thread is reco-
gnized worldwide and will make you happy
when carrying out your next project. Variation
of several bright colors.

Blanc/White	Beige	Bleu royal/ Royal Blue	Brun/Brown
Bleu granite/ Blue granite	Rouge/Red	Jaune/Yellow	Orange
Vert / Green	Noir/Black		



F33-500

Fil de nylon à perler. Bobine de 500 m.
Blanc ou noir.
Beads nylon thread, 500m spool.
White or black.

LANIÈRE POUR LAÇAGE / LACING STITCHING



Rouleau de lacet en cuir de veau (très résistant) pour laçage de vos projets. / *Calf leather lace spool for lacing your leather projects (very resistant)*

5007 1/8" (3mm) X 50v

Noir / Black	Brun foncé / Dark brown	Brun moyen / Medium brown	Naturel / Natural



Lacet de suède de première qualité, de type daim EcoSoft. / *Premium suede lace Ecosoft type.*

5080 3/32" (2,4mm) X 15.2m (50pi)

5081 1/8" (3mm) X 15.2m (50pi)

Noir / Black	Brun foncé / Dark brown	Brun moyen / Medium brown	Brun pâle / Light brown	Beige



27600

Lacet de faux suède 2.7mm (7/64") plat x 50 mètres; très résistant et souple. D'autres teintes disponibles / *Flat faux suede lace 2.7mm (7/64") x 50 meters; very resistant yet flexible. Other colors available.*

Noir / Black	Brun / Brown	Ivoire / Ivory	Rouge / Red	Turquoise	Blanc / White



Lacet Rond de cuir / *Leather round lace*

29921 = 1.5 mm

29920 = 2 mm

D'autres teintes disponibles / *Other colors available*

Noir / Black	Brun foncé / Dark brown	Brun moyen / Medium brown	Brun pâle / Light brown	Beige



Lacets de cuir 7-8 oz, pleine fleur coupés à 72", vendus à l'unité. Disponibles en 12 couleurs. /

Full grain leather 7-8 oz. cut to 72" sold individually. 12 colors available.

C = 1/8" (3 mm) (bottes, gants de baseball et artisanat / *boots, baseball gloves and crafts*)

D = 3/16" (4,5 mm)

E = 1/4" (6 mm)

Noir / Black	Brun foncé / Dark brown	Brun pâle / Light brown	Rouge / Red	Royal	Gris / Grey
Rouille / Rust	Rose / Pink	Blanc / White	Mauve / Purple	Tan	Crème / Cream



Babiche en lanières / *Rawhide straps*

3 largeurs offertes en rouleau replié sur lui-même / *3 widths offered folded on itself*

Utilisation / Use: pour fabriquer des raquettes, des assises ou tout autre objets utiles / *to make snowshoes, seats or any other useful objects*

#BAB14-100 : rouleau de 1/4" pour 170 pieds linéaires / *Roll of 1/4" for 170 linear feet*

#BAB38-100 : rouleau de 3/8" pour 130 pieds linéaires / *Roll of 3/8" for 130 linear feet*

#BAB12-100 : rouleau de 1/2" pour 98 pieds linéaires / *Roll of 1/2" for 98 linear feet*

Peut-être acheté via notre boutique en ligne/ *Can be purchased on our online store* : boutique.cuirsdessrochers.com

**Nous contacter pour d'autres lacets ou produits similaires non illustrés ici.
Contact us for other lace or similar product not shown here.**

AIGUILLES DIVERSES / VARIOUS NEEDLES



1190-00
Aiguilles à lacer à 2 griffes pour lanière 3/32",
paquet de 10 / 2-prong lacing needle
(10 / pack)

1194-00
Aiguilles à griffe et oeil de sécurité pour
lanière 3/32", paquet de 10 / Lok Eye
Needle (Hook-n-Eye) for lace (10/pk)



Aiguilles à visser en laiton pour lanières de cuir /
Screw type needles for laces.

1193-01 2 1/8" long – pour lanière/ for lace
3/32", 1/8"

1193-02 2 1/8" long, pour lanière / for lace
1/8", 5/32", 1/4"

1193-05 5" long pour lanière / for lace
1/8" à/to 1/4"



1195-00
Aiguilles à long chas, bout rond pour
couture à la main, paquet de 10. / Long eye
needles, round point for hand sewing.
(10/pk)



Grosse aiguille avec coude Osborne /
Osborne large needle bent pack

508400 4", gauge 12

508600 6", gauge 9



Pour couture au point «Sellier». Aiguilles à har-
nais Osborne #517 avec bout arrondi et chas
(25/pqt) / For saddle stitches. Osborne #517
harness needle (25/pkg)

517000 #000, 2 3/8", gauge 16 grosse/large

51700 #00, 2 3/8", gauge 17 moyenne/medium

5170 #0, 2 3/8", gauge 18 petite/small



50760
Grosse aiguille à 2 pointes diamants.
6" gauge 14 / 6", 14 ga., Leather needles
double diamond tips



Aiguilles à gants pointes de diamant
/ Diamond point gloves's needles
#518 ET 516 = Osborne

1191-11 n°1, 1 14/16" (Tandy 10)

51820 n°2, 1 13/16", gauge 19 (25)

51830 n°3, 1 11/16", gauge 20 (25)

1191-13 n°3, 1 11/16", (Tandy 10)

51850 n°5, 1 9/16", gauge 20 (25)

51870 n°7, 1 3/8", gauge 22 (25)

Pour tapis / for carpet :

51625 n°17, 2 1/2", gauge 17 (25)

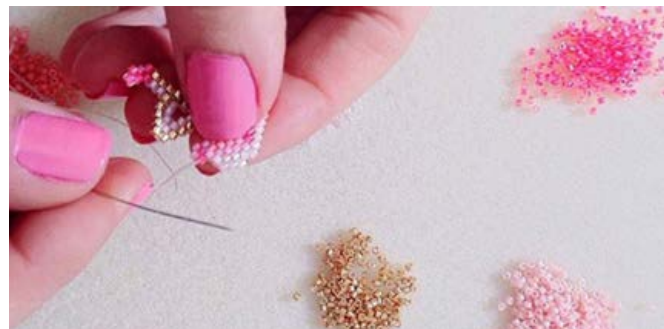

Aiguilles à perler / Beading needle (25/pack)

23031 #11, super fine, chas or/
Japanese quality, gold eye
(0.50mm x 33.3mm)

23032 #13, super fine, chas argent/
Silver eye (0.41mm x 54.6mm)

Autres grandeurs disponibles/Other size available



MR-K1

Aiguilles Osborne, paquet de 5 /
Osborne Needle kit of 5.

2 aiguilles courbées à rembourrage 3" et
4", 2 grosses aiguilles droites à pointe dia-
mant 2" et 3", 1 aiguille à canevas 2 1/2". /
2 curved needle 3" & 4", 2-diamond point
straight needles 2" & 3" & 1 canvas needle
2 1/2".



MR-K3 Grande / Tall

Aiguilles à coudre courbées Osborne,
3", 4", 5" et 6", paquet de 4 /
Osborne Round point Needle kit of 4: 3",
4", 5" & 6".

MR-K7 Petite / Small

2 1/2", 3", 3 1/2" et 4", paquet de 4
Kit of 4 : 2-1/2", 3", 3-1/2" & 4"



MR-K5

Aiguilles droites Osborne K5 paquet de 4,
longueurs 6", 8", 10", 12". /
Osborne Straight round point needles kit of
4: 6", 8", 10" and 12".

AIGUILLES / NEEDLES

AIGUILLE POUR ALÈNE / NEEDLE FOR SPEEDY STITCHER



Aiguilles pour alène «Speedy stitcher» /
Straight needle for Speedy Stitcher 1216-00

- 1216-130** petite/Small
- 1216-130A** grosse/Medium
- 1216-130B** courbée / Curved

(voir alène/see Speedy Stitcher [page 64](#))



MR-42

Aiguilles alène Osborne 1-1/2" pointe
diamant pour alène #928 et #145 /
Osborne needle for #928 and #145 stitcher
diamond point

(voir alène/see Sewing Osborne awl [page 64](#))



MR-54

Aiguilles pour alène Osborne 2" pour #928
et #145 / 2" Awl needles Osborne for #928
and #145.

(voir alène/see Sewing Osborne awl [page 64](#))



MJ-60201

Rondelle de cire d'abeille pour éviter
effilochage 0.08 lb. / Bees Wax natural
prevent fraying 0.08 lb.



HCIREP

Cire d'abeille Pure. 111g – fait au Québec/
Pur bee wax. 111g – made in Quebec



MR-266 (EX 3944.00)

Paume de couture Osborne en cuir avec
alvéole qui sert à faire une pression et à
protéger la main. Droitier ou gaucher.
Osborne leather sewing palm, with
alveolus that serves to pressure and protect
the hand. Right or left hand. Specify when
ordering.

AIGUILLES POUR MACHINE À COUDRE / SEWING MACHINE NEEDLES



A134-35LR

Aiguilles à machine à coudre walking
foot système 134-35 / Sewing machine
needles - walking foot system 134-35
90/14, 100/16, 110/18, 120/19,
130/21, 140/22, 160/23, 180/24, 200/.



Aiguilles pour machine à coudre de
cordonnerie Système 332 et 332 LG /
Needles for shoemaker's sewing
machine system 332 and 332LG

A332-29x3 90/14, 100/16, 110/18,
120/19, 130/21, 140/22,
160/23, 180/24

A332LG 100-160, 110/18, 120/19,
130/21, 140/22, 150/
160/23, 180/24, 200/



A81, A88

Aiguilles pour moulin Claes #81 ou
#88. / Needle for Claes no. 8 or # 88.

A81 100/2, 110/3, 120/4, 130/5,
140/, 160/, 170/7



A88 100/2, 110/3, 120/4, 130/5,
150/6, 170/7

ÉLASTIQUES PLATS / FLAT ELASTIC



POUR BRETelles (TRESSÉ) / FOR SUSPENDERS (WOVEN)

EW4252	1/2" noir ou blanc / black or white, fort / heavy duty
EW2018	3/4" noir ou blanc / black or white, fort / heavy duty
EW2025N	1" noir, fort / black, heavy duty
EW2038N	1 1/2", noir / black, fort / heavy duty
EW2051N5	2", noir / black, fort / heavy duty
EW1038N	1 1/2", noir, régulier / black, regular

TISSÉS / KNITTED ELASTIC

EW2506	1/4" noir ou blanc / black or white
EWP38	3/8" noir ou blanc / black or white
EW30213N	1/2" noir ou blanc / black or white
EW1254N	1" noir / black
EW3000N	3" noir / black
EW4302N	4" noir / black
EW5302N	5" noir / black

POUR JAMBIÈRE DE HOCKEY / FOR GOALER STRAPS

EW5551	1" noir ou blanc, fort / / black or white, heavy duty
---------------	---

ÉLASTIQUES RONDS / ROUND ELASTIC



EW1318	1,3 mm (1/16"), noir ou blanc / black or white (m)
EW2338N	2,3 mm (3/32"), noir / black (m)
EW20828N	2,8 mm (7/64"), noir / black (m)
EW3447N	3 mm (1/8"), noir / black (m)
EW3170N	6 mm (1/4"), noir / black

RUBAN VELOURS ET CROCHET / HOOK AND LOOP TAPE



Nos clients adorent!
Our customers love them.

YKK *
Little Parts. Big Difference.™

Ruban de velours et crochet YKK CANADA
disponible dans le noir et le blanc.

Couleurs assorties disponibles dans le 1" seulement.

YKK CANADA Hook and loop tape available in black or white.
Assorted colours available in 1 inch. only.

RÉGULIER / REGULAR

V34H	3/4" crochet / hook
V34L	3/4" velours / loop
V1H	1" crochet / hook
V1L	1" velours / loop
V15H	1 1/2" crochet / hook
V15L	1 1/2" velours / loop
V2H	2" crochet / hook
V2L	2" velours / loop
V4H	4" crochet / hook
V4L	4" velours / loop

AUTOCOLLANT / ADHESIVE

VAC34H	3/4" crochet / hook
VAC34L	3/4" velours / loop
VAC1H	1" crochet / hook
VAC1L	1" velours / loop
VAC15H	1 1/2" crochet / hook
VAC15L	1 1/2" velours / loop
VAC2H	2" crochet / hook
VAC2L	2" velours / loop
VAC4H	4" crochet / hook
VAC4L	4" velours / loop

* «YKK» and YKK Little Parts. Big Difference.™ are registered trademarks of YKK CORPORATION in Japan and other countries.

COURROIE D'AUTOMOBILE / CAR WEBBING



WSB2-NR 2" noir / black
100% polyester

COURROIE EN POLYPROPYLENE / POLYPROPYLENE WEBBING



Courroies en polypropylène Régulières ou fortes. /
Regular or Heavy duty polypropylene webbing

Disponible en rouleau de 50 V, 100v ou à la coupe. /
Available in 50 yards or 100 yds rolls or by yard.

WPP38NR	3/8" noire / black
WPP50	1/2" blanche ou noire / black or white
WPP58	5/8" blanche ou noire / black or white
WPP34	3/4" blanche ou noire / black or white
WPP34HD-NR	3/4" forte, noire / heavy duty, black
WPP1	1" noire ou blanc / black or white
WPP1HD-NR	1" forte, noire / heavy duty, black
WPP125-NR	1 1/4" noire / black
WPP125H-NR	1 1/4" forte, noire / heavy duty, black
WPP15	1 1/2" noire / black
WPP15HD-NR	1 1/2" forte, noire / heavy duty, black
WPP2-NR	2" noire / black
WPP2HD-NR	2" forte, noire / heavy duty, black

COURROIE EN NYLON / NYLON WEBBING



Rouleau de 50 v. Noir en stock et peut être coupé. Autres couleurs disponibles sur commande au rouleau complet de 50 vg seulement. Rolls of 50 yards. Black in stock and may be cut. Other colors available on request by rolls of 50 yards only.

WN58HD-NR	5/8" forte/ heavy duty
WN34HD-NR	3/4" forte/ heavy duty
WN1-NR	1"
WN1HD-NR	1" forte/ heavy duty - 100 vg.
WN1HD-JE	1" forte/ heavy duty
WN15HD-NR	1 1/2" forte/ heavy duty
WN2HD-NR	2" forte/ heavy duty

COURROIE EN POLYESTER / POLYESTER WEBBING

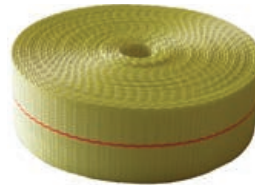

Jaune avec ligne orange, rouleau de 10v. / Yellow with orange strip,
Rolls of 10 yards..

WP2Y	2"
-------------	----

COURROIE DE NYLON TYPE «PLONGÉE» DIVER WEBBING NYLON



Courroie forte et rigide, noire. / Heavy duty and rigid webbing, black.

PDW2HD- NR	2"
-------------------	----

FERMETURES À GLISSIÈRE / ZIPPERS

LÉGENDE GÉNÉRALE / GENERAL PRODUCT LEGEND

PRODUITS, ÉQUIVALENCES CANZIP, YKK OU AUTRES. / EQUIVALENTS, CANZIP, YKK OR OTHERS.



MÉTAL / METAL

Appellation / Type : **5, 10**

Laiton, Nickel sur laiton ou Aluminium
Brass, Nickel on Brass or Aluminum



SPIRAL / COIL

Appellation / Type : **3C, 4-5C, 5C, 8C, 10C**

Aussi appelé/Also called :

3C = S40

5C = RT10

10C = RT25



PLASTIQUE / PLASTIC

Appellation / Type : **5V, 8V, 10V ...**

Aussi appelé / Also called :

5V = M6

10V = M9

(L'appellation VISLON est une marque déposée de YKK. Myelin est pour Canzip. The name VISLON is a registered trademark of YKK. Myelin is for Canzip)



DA

DOUBLE ARRÊT / DOUBLE STOP

Non séparable. Curseur à chaque bout, se coupe en 2. / Non separable. Slider at each end. May be cut in 2 parts.



2W

2 DIRECTIONS / '2 WAY'

Séparable. Curseur à chaque bout. / Separable. Slider at each end.



2T

2 TIRETTES À 1 CURSEUR / 2 PULLS AT 1 SLIDER

Séparable / Separable

LÉGENDE / LEGEND

NL : non verrouillé / no-lock

Auto : verrouillé / lock

2T : 2 tirettes / Double pulls

GT : grande tirette / long pull

INV : inversé (invisible) / invisible

REV : réversible (rotation d'avant vers l'arrière)
s'ouvre du devant ou derrière / The pull
moves along a rotating rail. The zipper
opens and closes from either the front
or back (Automatic).

CANZIP

YKK *
Little Parts. Big Difference.™

* «YKK» and YKK Little Parts. Big Difference.™ are registered trademarks of YKK CORPORATION in Japan and other countries.

FERMETURES À GLISSIÈRE DENTS EN MÉTAL / METAL TEETH ZIPPERS



- Séparable
- Auto bloquante
- ruban 5/8"
- Separable
- Locked slider
- 5/8" tape

CHARTE DE COULEURS

1 NOIR / BLACK Canzip (001) ou/or YKK (580)	2 BLANC / WHITE Canzip (024)	3 BRUN FONCÉ / DARK BROWN Canzip (914) ou/or YKK (570)
4 BLEU MARIN / NAVY Canzip (200) ou/or YKK (058)	5 BEIGE Canzip (903)	6 BRUN MOYEN / MEDIUM BROWN Canzip (916)
7 BLEU MARIN FONCÉ / DARK NAVY Canzip (206) ou/or YKK (560)(233)	8 BRUN NOIR / BROWN BLACK Canzip (913) ou/or YKK (916)	

DENTS DE LAITON ANTIQUE / ANTIQUE BRASS METAL TEETH

#5



#5—7"

- 1** 5B7A-YKK-580
- 4** 5B7A-YKK-058
- 8** 5B7A-YKK-916

#5—30"

- 1** 5B30A-CZP-001
5B30A-YKK-580
- 4** 5B30A-CZP-200
- 3** 5B30A-CZP-914
5B30A-YKK-570
- 6** 5B30A-CZP-916
- 8** 5B30A-CZP-913

#5—36"

- 1** 5B36A-CZP-001
5B36A-YKK-580
- 4** 5B36A-CZP-200
- 3** 5B36A-YKK-570
- 6** 5B36A-CZP-916
- 7** 5B36A-CZP-206
- 8** 5B36A-CZP-913

#5—36" — 2 directions / 2 Way (2W)

- 1** 5B36A-2W-CZP-001
5B36A-2W-YKK-580
- 3** 5B36A-2W-YKK-570
- 4** 5B36A-2W-CZP-200
- 7** 5B36A-2W-YKK-233
- 8** 5B36A-2W-CZP-913

#5 -2W



#10



#10—30"

- 1** 7B30A-CZP-001
10B30A-580
- 4** 7B30A-CZP-200
- 7** 7B30A-CZP-206
10B30A-560
- 8** 7B30A-CZP-913

#10—36"

- 1** 7B36A-001
10B36A-580

DENTS DE NICKEL / NICKEL TEETH

#5



#5—36"

- 1** 5N36-YKK-580

#5 - 2W



#5—36" — 2 directions / 2 Way (2W)

- 1** 5N36-2W-YKK-580

DENTS D'ALUMINIUM / ALUMINUM TEETH

#10



#10—30"

- 1** 7A30-001

#10—36"

- 1** 7A36-001

#10—36"
2 directions / 2 Way (2W)

- 1** 10A36-580-2W

#10-2T



#10—72" — 2 tirettes / 2 pulls (2T)

- 2** 7A-72NL-024-2T

#10—96" — 2 tirettes / 2 pulls (2T)

- 1** 7A-96NL-2T-CZP-001
- 2** 7A-96NL-2T-CZP-024
- 5** 7A-96NL-2T-CZP-903

FERMETURES À GLISSIÈRE AVEC DENTS EN PLASTIQUE / PLASTIC ZIPPERS



- Séparable
- Auto bloquante
- ruban 5/8"
- Separable
- Locked slider
- 5/8" tape

CHARTRE DE COULEURS Les couleurs réelles peuvent différer / Actual colors may differ.

1 NOIR / BLACK Canzip (001) ou/or YKK (580)	2 BLANC / WHITE Canzip (024) ou/or YKK (501)	3 BRUN MOYEN / MEDIUM BROWN Canzip (914)
4 MARINE / NAVY Canzip (200) ou/or YKK (058) (560)	5 BEIGE MOYEN / MEDIUM BEIGE Canzip (903)	6 CAFÉ / COFFEE Canzip (922)
7 MARINE FONCÉ / DARK NAVY Canzip (206) ou/or YKK (960)	8 BRUN-FONCÉ / DARK-BROWN Canzip (913)	9 VERT FORÊT / FOREST GREEN Canzip (400)
10 GRIS FONCÉ / CHARCOAL Canzip (002)	11 BEIGE PÂLE Canzip (054)	12 KAKI / KAKHI Canzip (535) ou/or YKK (567)
13 GRIS / GREY Canzip (034) ou/or YKK (118)	14 TAUPE Canzip (959)	15 PAPRIKA Canzip (929)
16 MAUVE / PURPLE Canzip (108)	17 ORANGE BRÛLÉ / BRUNT ORANGE Canzip (933)	18 CACAO / COCOA Canzip (916)
19 BOURGOGNE / BURGUNDY Canzip (732)	20 ROUILLE / RUST Canzip (976) ou/or YKK (858)	21 BRUN MOYEN / MID BROWN Canzip (974)
22 ROUGE / RED Canzip (739) ou/or YKK (059)	23 BLEU ROYALE / BLUE BLEU YKK (918)	

DENTS COULEUR NICKEL / NICKEL TEETH

#5VS OU/OR 5V



#5VS (YKK) OU /OR 5V (CANZIP) — 30"

- 1** M630-580S (YKK)
M630-001S (CZP)

DENTS COULEUR OR ANTIQUE / ANTIQUE GOLD TEETH

#5V



#5V — 30"

- 1** M630-001A (CZP)

DENTS MÊME COULEUR QUE RUBAN / TAPE SAME COLOR AS TEETH

#5VS OU/OR 5V



#5VS (YKK) OU /OR 5V (CANZIP) — 30"

- | | | |
|--|--|--|
| 1 M630-CZP-001
M630-YKK-580 | 2 M630-CZP-024
M630-YKK-501 | 3 M630-CZP-914 |
| 4 M630-CZP-200
M630-YKK-058 | 5 M630-CZP-903 | 6 M630-CZP-922 |
| 7 M630-CZP-206
M630-YKK-960 | 8 M630-CZP-913 | 9 M630-CZP-400 |
| 10 M630-CZP-002 | 11 M630-CZP-054 | 12 M630-CZP-535
M630-YKK-567 |
| 13 M630-CZP-034
M630-YKK-118 | 14 M630-CZP-959 | 15 M630-CZP-929 |
| 16 M630-CZP-108 | 17 M630-CZP-933 | 18 M630-CZP-916 |
| 19 M630-CZP-732 | 20 M630-CZP-976
M630-YKK-858 | 21 M630-CZP-974 |
| 22 M630-CZP-739
M630-YKK-059 | 23 M630-YKK-918 | |

FERMETURES À GLISSIÈRE AVEC DENTS EN PLASTIQUE / PLASTIC ZIPPERS

DENT MÊME COULEUR QUE RUBAN / TAPE SAME COLOR AS TEETH

#5VS OU/OR 5V



#5VS (YKK) OU /OR 5V (CANZIP)—36"

- 1 M636-CZP-001
M636-YKK-580

#5VS OU/OR 5V



#5VS (YKK) OU /OR 5V (CANZIP)—36" 2 directions / 2 Way (2W)

- 1 M636-2W-CZP-001
M636-2W-YKK-580
- 3 M636-2W-CZP-914
- 4 M636-2W-CZP-200
- 8 M636-2W-CZP-913

NOUVEAU / NEW

#8V



#8V AUTO/LOCK (YKK)—30"

- 1 M830-YKK-580

#10VS OU/OR 10V



#10VS (YKK) OU /OR 10V (CANZIP)—30"

- 1 M930-CZP-001
M630-YKK-580
- 4 M930-CZP-200
- 8 M930-CZP-913

#10VS OU/OR 10V



#10VS (YKK) OU /OR 10V (CANZIP)—36" 2 directions / 2 Way (2W)

- 1 M930-CZP-2W-001
M930-YKK-2W-580
- 4 M930-CZP-2W-200
M930-YKK-2W-560
- 8 M930-CZP-2W-913

FERMETURES À GLISSIÈRE SPIRALE / COIL ZIPPERS



- ruban 5/8"
- 5/8" tape

CHARTRE DE COULEURS

Les couleurs réelles peuvent différer / *Actual colors may differ.*

1 NOIR / BLACK Canzip (001) ou/or YKK (580)	2 BLANC / WHITE Canzip (024) ou/or YKK (501)	3 BRUN FONCÉ / DARK BROWN Canzip (914) ou/or YKK (916)
4 MARINE / NAVY Canzip (200) ou/or YKK (058) (560)	5 BEIGE MOYEN / MEDIUM BEIGE Canzip (903)	6 CAFÉ / COFFEE Canzip (922) ou/or (T292)
7 MARINE FONCÉ / DARK NAVY Canzip (206) ou/or YKK (960)	8 BRUN-NOIR / BLACK-BROWN Canzip (913)	9 TAN YKK (858) (161)
10 GRIS FONCÉ / CHARCOAL Canzip (002)	11 BLANC CASSÉ / OFF WHITE Canzip (050)	12 KAKI / KAKHI Canzip (535) ou/or YKK (567)
13 GRIS / GREY Canzip (041) ou/or YKK (860)	14 TAUPE Canzip (536)	15 BRUN MOYEN / MEDIUM BROWN Canzip (916) ou/or YKK (570)
16 GRIS PÂLE / PEARL Canzip (030) ou/or YKK (132) (133)	17 BEIGE PÂLE YKK (573)	18 ROUILLE / RUST Canzip (976) ou/or YKK (093)
19 BRUN ROUILLE / RUST BROWN YKK (855)	20 CACAO YKK (854) (563)	21 ROUGE / RED Canzip (739)
22 BLEU ROYALE / BLUE BLEU YKK (918)		

DENT MÊME COULEUR QUE RUBAN / TAPE SAME COLOR AS TEETH

#3C



#3C—10" — Non séparable / Non separable

1 S40-10-CZP-001 S40-10-YKK-580	2 S40-10-CZP-024	3 S40-10-CZP-914	4 S40-10-CZP-200
5 S40-10-CZP-903	7 S40-10-CZP-206	8 S40-10-CZP-913 S40-10-YKK-916	10 S40-10-CZP-002
12 S40-10-CZP-535	13 S40-10-YKK-860	14 S40-10-CZP-536	21 S40-10-CZP-739

#5C



#5C—7" — Non séparable / Non separable

1 RT10-7-CZP-001 RT10-7-YKK-580	2 RT10-7-CZP-024	3 RT10-7-YKK-916	4 RT10-7-CZP-200 RT10-7-YKK-058 RT10-7-YKK-560
8 RT10-7-CZP-913	12 RT10-7-CZP-535		

#5C



#5C—30" — Séparable / Separable

1 RT10-30-CZP-001 RT10-30-YKK-580	2 RT10-30-CZP-024	3 RT10-30-CZP-914	4 RT10-30-CZP-200 RT10-30-YKK-058 RT10-30-YKK-560
6 RT10-30-CZP-T292	7 RT10-30-CZP-206 RT10-30-YKK-960	8 RT10-30-CZP-913	10 RT10-30-CZP-002
11 RT10-30-CZP-050	13 RT10-30-CZP-041	18 RT10-30-YKK-093	22 RT10-30-YKK-918

#5C—30" — Séparable / Separable, IMPERMÉABLE / WATERPROOF

1 RT10-30-YKK-IMP-580

FERMETURES À GLISSIÈRE SPIRALE / COIL ZIPPERS

#5C



#5C—30" — **Double arrêts / Double stop (DA)** — **Non séparable / Non separable**

- | | | | |
|---|---|--|---|
| 1 RT10-30-DA-CZP-001
RT10-30-DA-YKK-580 | 3 RT10-30-DA-CZP-914
RT10-30-DA-YKK-916 | 4 RT10-30-DA-YKK-560 | 5 RT10-30-DA-CZP-903 |
| 6 RT10-30-DA-CZP-922
RT10-30-DA-CZP-T292 | 8 RT10-30-DA-CZP-913 | 9 RT10-30-DA-YKK-858
RT10-30-DA-YKK-161 | 11 RT10-30-DA-CZP-050 |
| 13 RT10-30-DA-CZP-041 | 16 RT10-30-DA-CZP-030
RT10-30-DA-YKK-132 | 17 RT10-30-DA-YKK-573 | 18 RT10-30-DA-CZP-976
RT10-30-DA-YKK-093 |
| 19 RT10-30-DA-YKK-855 | 20 RT10-30-DA-YKK-854
RT10-30-DA-YKK-563 | 21 RT10-30-CZP-739 | |

#5C



#5C—36" — **Séparable / Separable**

- 1 RT10-36-CZP-001
RT10-36-YKK-580

#5C



#5C—30 ou/ou 36" — **Séparable / Separable** — **2 directions / 2 Way (2W)**

- 30"
1 RT10-30-2W-YKK-580

- 36"
1 RT10-36-2W-CZP-001
RT10-36-2W-YKK-580
3 RT10-36-2W-YKK-916
4 RT10-36-2W-CZP-200
8 RT10-36-2W-CZP-913
15 RT10-36-2W-CZP-916

#5C



#5C—120" — **Ne barre pas / Non lock** — **2 tirettes / 2 pulls (2T)**

- 1 RT10-120NL-CZP-2T-001

NOUVEAU / NEW

#8C



#8C (YKK)—30" — **Séparable / Separable**

- 1 RT20-30-YKK-580

#10C



#10C—30" — **Séparable / Separable**

- 1 RT25-30-CZP-001
RT25-30-YKK-580
4 RT25-30-CZP-200
7 RT25-30-CZP-206
8 RT25-30-CZP-913



#10C—36" — **Séparable / Separable** — **2 tirettes / 2 pulls (2T)** — **RUBAN 1"/1" TAPE**

- 1 RT25-96-0012T-1

#10C—36" — **Séparable / Separable**

- 1 RT25-36-CZP-001
RT25-36-YKK-580

FERMETURES À GLISSIÈRE VENDU AU ROULEAU OU À LA COUPE / ZIPPERS BY ROLL OR SOLD TO CUT



MINIMUM 5 VERGES / YARD

Complétez avec les curseurs assortis, consultez la section suivante. / Complete with assorted sliders, see further section.

CHARTE DE COULEURS

Les couleurs réelles peuvent différer / Actual colors may differ.

1 NOIR / BLACK
Canzip (001) ou/or YKK (580)

2 BLANC / WHITE
Canzip (024) ou/or YKK (501)

3 BRUN CHOCOLAT / CHOCOLATE BROWN
Canzip (913) ou/or YKK (570)

- ruban 5/8"
- 5/8" tape

PLASTIQUE DENT MÊME COULEUR QUE RUBAN / PLASTIC TAPE SAME COLOR AS TEETH



#5V 
1 M6C-001

SPIRALE DENT MÊME COULEUR QUE RUBAN / COILTAPE SAME COLOR AS TEETH



1" - 5/8"

#3C 
1 S40C-001

#4,5C
1 4.5C-580

#5C
1 RT10C-001
RT10C-580
2 RT10-501-YKK
3 RT10C-913

#5C - RUBAN 1" / 1" TAPE

1 RT10C-580-YKK-1PC

#8C
1 8CC-580-YKK

3 8CC-570-YKK

#10C
1 RT25C-001
RT25C-580
2 RT25C-024
RT25C-501-YKK

DENT DE MÉTAL / METAL TEETH TAPE

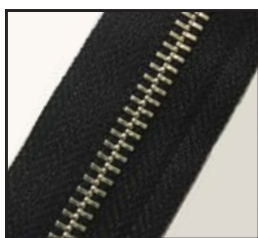

#5 
1 5BC-580-NIC-YKK
Dents nickel / Nickel Teeth

1 5BC-580-OR-YKK
Dents laiton / Brass Teeth

CURSEURS POUR FERMETURE À GLISSIÈRE EN MÉTAL / SLIDERS FOR METAL ZIPPERS

Les 2 marques de curseur YKK et CZP sont compatibles sur les chaînes de métal / Both marks are compatible on metal chain.



#5—CZP (AUTO)

- 5BS-NIC Nickel
- 5BS-GM Gun Metal
- 5BS-AB Laiton antique / Antique brass
- 5BS-OR Or / Gold **NOUVEAU / NEW**



#5—YKK (AUTO)

Tirette à boule / ball pull (fashion)

- 5BS-NIC-YKK-DA8 Nickel
- 5BS-OR-YKK-DA7 Or / Gold

#5—YKK (NON VÉROUILLÉ/ NON LOCK)

- 5BS-NL-NIC-YKK-DF Nickel



#5—YKK (NON VÉROUILLÉ/ NON LOCK)

- 5BS-NL-NIC-YKK Nickel
- 5BS-NL-OR-YKK Or / Gold



#10—CZP (AUTO)

- 7BS-NIC Nickel
- 7BS-AB Laiton antique / Antique brass



#10—CZP (2 TIRETTES / 2 PULLS)

- 7BS-NIC-2T Nickel

CURSEURS POUR FERMETURE À GLISSIÈRE EN PLASTIQUE / SLIDERS FOR PLASTIC ZIPPERS

Tous sont auto / All are auto.



#5VS—YKK (AUTO)

1. M5VS-580 Noir / Black
 2. M5VS-SA Argent / Silver
- M5VS-GM Gun Metal



#5VS—YKK (AUTO) BAS

- M5VSBAA Argent antique / Antique Silver
- M5VSBN Noir / Black



**NOUVEAU MODÈLE
NEW MODEL**

#5V—CZP (AUTO) - PROFIL 5VS SHAPE

- M6S-001-5VS Noir / Black
- M6S-AB-5VS Laiton antique / Antique brass
- M6S-GM-5VS Gun Metal
- M6S-NIC-5VS Nickel
- M6S-200-5VS Marine / Navy
- M6S-SA-5VS Nickel



**JUSQU'À ÉPUISEMENT
WHILE STOCKS LAST**

#5V—CZP (AUTO)

- M6S-001 Noir / Black
- M6S-AB Laiton antique / Antique brass
- M6S-GM Gun Metal
- M6S-NIC Nickel
- M6S-914 Brun foncé / Dark brown
- M6S-200 Marine / Navy



#5V —CZP (AUTO) BAS

- M6S-001-BAS Noir / Black



#5V—CZP (AUTO) RÉVERSIBLE /REVERSIBLE

- M6S-001-R Noir / Black
- 1. M6S-AB-R Laiton antique / Antique brass
- 2. M6S-NIC-R Nickel

CURSEURS POUR FERMETURE ÉCLAIRE EN PLASTIQUE / SLIDERS FOR PLASTIC ZIPPERS

Tous sont auto / All are auto.



#8V—YKK (AUTO)

1. M8V-580 Noir / Black



#8VS—YKK (AUTO)

M8VS-580 Noir / Black



#10V—CZP (AUTO)

M9S-001 Noir / Black
M9S-024 Blanc / White



#10V—CZP (AUTO) - BAS

M9S-001-bas Noir / Black

CURSEURS POUR FERMETURE À GLISSIÈRE SPIRALE / SLIDERS FOR COIL ZIPPERS



#3C—CZP (AUTO)

S40S-001 Noir / Black



#4C—JEF (NON VÉROUILLÉ / NON LOCK)

4SI-NL-001 Noir / Black



#4.5C—YKK (AUTO)

4.5S-580 Noir / Black



#4.5C—YKK (NON VÉROUILLÉ / NON LOCK)

4.5SNL-580 Noir / Black



#5C—JEF (AUTO)

5SI-001 Noir / Black



#5C—JEF (NON VÉROUILLÉ / NON LOCK)

5SI-NL-001 Noir / Black



#5C—JEF (NON VÉROUILLÉ, 2 TIRETTES) / JEF (NON LOCK, 2 PULLS)

5SI-NL-0012T Noir / Black



#5C—CZP (AUTO)

RT10S-AB Laiton antique / Antique brass
RT10S-914 Brun foncé / Dark brown
RT10S-NIC Nickel
RT10S-001 Noir / Black

CURSEURS POUR FERMETURE À GLISSIÈRE SPIRALE / SLIDERS FOR COIL ZIPPERS



#5C—CZP (NON VÉROUILLÉ / NON LOCK)

RT10S-NL-NIC Nickel
RT10S-NL-001 Noir / Black



#5C—YKK (AUTO)

RT10S-580 Noir / Black
RT10S-GM-YKK Gun Metal
RT10S-NIC-YKK Nickel



#5C—YKK (NON VÉROUILLÉ / NON LOCK)

RT10S-NL-OR-YKK Or / Gold
RT10S-NL-580 Noir / Black
RT10S-NL-NIC-YKK Nickel
RT10S-NL-AB-YKK Laiton antique / Antique brass
RT10S-NL-GM-YKK Gun Metal



#5C—CZP AUTO - (2 TIRETTES / 2 PULLS)

RT10S-001-2T Noir / Black



#5C (AUTO) BAS / BOTTOM

CZP # RT10S-001-BAS Noir / Black
YKK # RT10S-580-BAS Noir / Black



#5C—CZP (AUTO - GRANDE TIRETTES / LONG PULLS)

RT10S-001-GT Noir / Black
RT10S-NIC-GT Nickel



#5C—YKK (AUTO - GRANDE TIRETTES / LONG PULLS)

RT10S-580-GT Noir / Black



#5C—YKK (AUTO - INVERSÉ/INVISIBLE)

RT10S-GM-INV-YKK Gun Metal
RT10S-580-INV-YKK Noir / Black



#8C—YKK (AUTO)

8CS580 Noir, petite tirette / Black short tab
8CS-570-YKK Brun foncé / Dark brown



#8C—YKK (NON VÉROUILLÉ / NON LOCK)

GRANDE TIRETTES / LONG PULLS
8CSNL-580-GT Noir / Black

2 TIRETTES / 2 LONG PULLS
8CSNL-580-2T Noir / Black



#8C—YKK (AUTO) - GRANDE TIRETTES / LONG PULLS

8CS580-GT Noir / Black



#8C—JEF (NON VÉROUILLÉ / NON LOCK)

8SI-NL-001 Noir / Black

CURSEURS POUR FERMETURE À GLISSIÈRE SPIRALE / SLIDERS FOR COIL ZIPPERS



#8C—JEF (NON VÉROUILLÉ 2 TIRETTES /
NON LOCK - 2 PULLS)

8SINL-0012T Noir / Black



#10C—CZP (AUTO)

RT25S-001 Noir / Black



#10C—YKK (AUTO)

RT25S-NIC-YKK Nickel
RT25S-580-YKK Noir / Black



#10C—CZP (NON VÉROUILLÉ / NON LOCK)

RT25S-NL-001 Noir / Black



#10C—YKK (NON VÉROUILLÉ / NON LOCK)

RT25S-NL580 Noir / Black
RT25SNL-NIC-YKK Nickel



#10C—CZP (NON VÉROUILLÉ 2 TIRETTES /
NON LOCK - 2 PULLS)

RT25S-NL-001-2T Noir / Black



#10C—YKK (NON VÉROUILLÉ 2 TIRETTES /
NON LOCK - 2 PULLS)

RT25S-NL580-2T Noir / Black
RT25S-NLNIC-2T-YKK Nickel



#10C—JEF (NON VÉROUILLÉ 2 TIRETTES /
NON LOCK - 2 PULLS)

10SINL-0012T Noir / Black

ARRÊTS / STOPPERS



#5—ARRÊT DU BAS 4 GRIFFES / BOTTOM STOPPER 4 CLAWS

Utilisé sur ferموir spiral et plastique /
Used on Coil & Plastic zipper

B5N Noir / Black
B5GM Gun Metal
B5NIC Nickel
B5OR Or / Gold

Utilisé sur ferموir de métal / *Used on metal zipper*
B5ML Laiton antique / *Antique brass*



#10—ARRÊT DU BAS 4 GRIFFES / BOTTOM STOPPER 4 CLAWS

Utilisé sur ferموir spiral et plastique /
Used on Coil & Plastic zipper

B10NR Noir / Black



#5—ARRÊT DU HAUT FORME EN U / TOP STOPPER U SHAPE

Utilisé sur spiral et plastique / *Used on Coil & Plastic*

H50A Laiton antique / *Antique brass*
H5GM Gun Metal
H5NIC Nickel
H5OR Or / Gold



#5—ARRÊT DU HAUT FORME EN L / TOP STOPPER L SHAPE

Utilisé sur spiral et plastique / *Used on Coil & Plastic*

H5LN Noir / Black
H5LOA Laiton antique / *Antique brass*
H5L200 Bleu marin / *Navy*



#10—ARRÊT DU HAUT FORME EN U / TOP STOPPER U SHAPE

Utilisé sur spiral et plastique / *Used on Coil & Plastic*

H10NR Noir / Black
H10A Laiton antique / *Antique brass*
H10NIC Nickel
H100 Or / Gold



#5—ARRÊT DU HAUT 3 GRIFFES / TOP STOPPER 3 CLAWS

Utilisé sur spiral / *Used on Coil*

H53NIC Nickel



#8—ARRÊT DU HAUT 3 GRIFFES / TOP STOPPER 3 CLAWS

Utilisé sur spiral / *Used on Coil*

H103NIC Nickel

MOUSSE ET CAOUTCHOUC / FOAM AND RUBBER

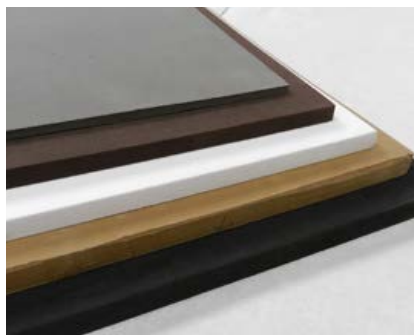

MOUSSES D'ÉLEVATION / FOAM ELEVATION

Feuilles 18" x 36" toutes disponibles dans ces couleurs / Sheets of 18" x 36" all available in these colours: beige, blanc, brun, gris et noir / beige, white, brown, grey and black

Cloud (CL) Pour orthèses plantaires / For plantar orthoses

Cette mousse est souple et moins dense que le Soflex et offre alors un bon confort.
This foam is supple and less stiff than Soflex and offer a great comfort.

Épaisseurs offertes / Thicknesses available : 1/4", 3/8", 1/2", 5/8", 3/4" et / and 1"
Densité / Density: de / from 1/4" = 12 iron à / to 1" = 48 iron

Soflex (SF) Pour les élévations / For footwear elevations

Cette mousse offre une densité accrue et est utilisée pour la semelle externe
This foam is stiff and is used for footwear elevation

Épaisseurs offertes / Thicknesses available : 1/8", 1/4", 3/8", 1/2" et / and 3/4"

GY-KENEBEC25



GY-PROTEC2

CAOUTCHOUC / RUBBER

Seulement offert dans le noir / Only offer in black
Caractéristique / Spec. : antidérapant / anti-skid

Pour les semelles / for outsoles :

GY-KENEBEC25 : Kenebec 2,5 mm, feuille 13-3/4"x15-3/4" / 2,5mm, Kenebec, sheet 13-3/4"x15-3/4"
GY-PROTEC2 : Protect 2mm, feuille 18"x36" / Protect 2mm, sheet 18"x36"

Pour les talons / for Heels:

GY-NEOLITE55 : Toplift Neolite 5,5 mm 2 plis, feuille de 18"x18" / Toplift Neolite 5,5mm super cushion, sheet 18"x18"
GY-CHEVRON64 : 6.4 mm en forme de chevron, feuille de 18"x22" / Chevron Soling 6.4mm 18"x22"
GY-CHEVRON8 : 8 mm en forme de chevron, feuille de 18"x22" / Chevron Soling 8mm 18"x22"

GY-NEOLITE55

GY-CHEVRON64

GY-CHEVRON8

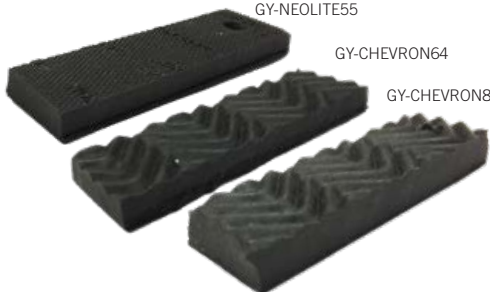

CRÊPE NATUREL / NATURAL CREPE

Utilité / Use : Gomme naturelle antidérapante et confortable pour les semelles des mocassins ou autres usages / Natural gum comfortable and non-slip sole for mocassins outsole or other uses.

Teinte / Color : naturel (blanc laiteux / offwhite)

Grandeur / size : 15" x 60"

#3994-14 : 1/4" (6mm) d'épaisseur / thickness

#3994-18 : 1/8" (3mm) d'épaisseur / thickness

Autres épaisseurs sur demande avec commande minimale / Other thicknesses on request with a minimum order.



BOUTON PRESSION SÉRIE 80 ET 95 / 80 AND 95 SERIES SNAPS FASTENERS

Les boutons pression de ces 2 séries sont tous antirouille et toutes les parties sont vendues séparément par multiple de 100.

Les couleurs des finis disponibles pour les 4 parties sont : / T

The snaps on these 2 series are all rust-proof and all parts are sold separately in multiples of 100. The colors of the finishes available for the 4 parts are:



Nous offrons aussi les têtes des boutons pression suivantes : /
We also offer the following these finishes for the caps



BOUTONS PRESSION SÉRIE 80 / 80 SERIES SNAP FASTENERS

12 mm (1/2") Tête / Cap 8020 H=4mm	Femelle / Socket 8021	Mâle / Stud 8031	Poteau / Post 8041 H=4 mm (court/short) et 8042 H=6 mm (long/long)

BOUTONS PRESSION SÉRIE 95 / 95 SERIES SNAP FASTENERS

15 mm (5/8") Tête / Cap 9524 H=4 mm (Régulier/Regular) 95124 H=6 mm (Long/Long)	Femelle / Socket 9521	Mâle / Stud 9531	Poteau / Post 9541 H=6 mm (Court/Short) 9542 H=8 mm (Long/Long)

BOUTONS FRANÇAIS / EUROPEEN FASTENERS

Série 844 - 15 mm (5/8") - 844 serie

Antirouille / Anti rust

Finis disponibles / Available finishes : gun metal, or antique, nickel chrome / gun metal, antique brass, chrome nickel.



Voir section **Outils** pour la pose de bouton pression
See **tooling** section to install button.

BOUTON PRESSION ET BOUTON / SNAPS FASTENERS AND BUTTON

BOUTONS PRESSION SPÉCIALISÉS «PULL THE DOT» / SPECIALIZED BUTTON SNAPS

Sac de 100
Sold by 100

Qu'est ce que 'pull the Dot' ? Système de blocage très sécuritaire et résistant à une pression accrue.

Utilité: produits de cuir, toiles, à des fins militaires ou plus !
Disponible en nickel antirouille seulement.

What is it? Locking system very safe and resistant to increased pressure.

Uses: *Leather goods, canvas, military end applications.*
Only available in nickel antirust



9524N-AR-P.DOT
Tête / Head



9521N-AR-P.DOT
Femelle/Socket



9531N-AR-P.DOT
Mâle / Stud clinch



9542N-AR-P.DOT
Poteau / post Eyelet
5/16" (8mm)

BOUTON À JEANS / JEANS BUTTONS

Comprends bouton et clou./
Include Cap and nail.

Sac de 12
Sold by 12

Sac de 100
Sold by 100



MR2010N
MR2010A
MR2010GM

Nickel
Or Antique / *Antique gold*
Gun metal



MR716
Clou lisse pour bouton à jeans
Rivet tack for jeans button

GOUJON DE BOUTONS PRESSION / SNAP BUTTON STUD

Goujon de stainless acier plaqué nickel. /
Screw in stainless stud in steel nickel plated.

Sac de 12
Sold by 12



B4078 Hauteur de /Height : 7/16" (un.)
B4080 Hauteur de /Height : 5/8" (un.)



OEILLETS / GROMMETS Toutes nos pièces sont vendues séparément par sac de 100, 1 000 et 2 000. Vous devez commander l'oeillet et la rondelle . / **All pieces are sold separately by bag of 100, 1 000 and 2000. You must order the grommet and the washer.**



RONDELLES / WASHERS

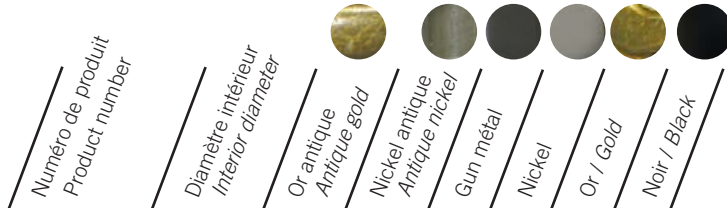

Numéro de produit / Product number	Diamètre intérieur / Interior diameter	Or antique / Antique gold	Nickel antique / Antique nickel	Gun métal	Nickel	Or / Gold	Noir / Black
Acier / Steel							
#50	1/4"	X	X	X	X	X	X
#51	3/16"	X		X	X	X	
#52	11/64"	X		X	X	X	
#54	5/32"	X		X	X	X	
#VE31	5/16"	X			X		
#VE40	3/8"	X			X		
#VE50	7/16"				X	X	
#VE60	1/2"				X	X	
#VL31	5/16"				X		
#VL40	3/8"				X		
#VL50	7/16"				X		
#VL60	1/2"				X	X	

«Sheet» antirouille / Rust free «sheet»							
#00	3/16"	X		X	X		
#0	1/4"	X		X	X	X	
#1	5/16"				X	X	
#2	3/8"	X			X	X	
#3	7/16"	X			X	X	
#4	1/2"	X			X	X	
#5	5/8"				X	X	

Oeillet à griffes «spur» antirouille / Claws grommets "spur" in brass.							
Sac de 50 ou 100 incluent œillets et rondelles. / (Bag of 50 or 100 includes grommets and washers).							
#0	5/16"					X	
#1	3/8"					X	
#2	7/16"					X	
#3	1/2"					X	
#4	5/8"					X	

Oeillets à patin / Skates grommet							
Sac de 50 inclus œillets et rondelles / Bag of 50 including grommet and washer.							
La mesure est la hauteur de la cheminée / The measure is the height of the chimney							
#51XL	1/4"						X
#51XXL	3/16"						X

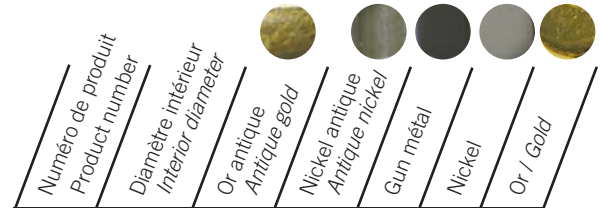

Numéro de produit / Product number	Diamètre intérieur / Interior diameter	Or antique / Antique gold	Nickel antique / Antique nickel	Gun métal	Nickel	Or / Gold	
Acier / Steel							
#R50	1/4"	X			X		
#R51	3/16"	X		X	X		
#R52	11/64"	Utiliser R51/Use					
#R54	5/32"	X			X		
#RVE31	5/16"	X			X		
#RVE40	3/8"	X			X		
#RVE50	7/16"				X	X	
#RVE60	1/2"				X	X	
#RVL31	5/16"				X		
#RVL40	3/8"				X	X	
#RVL50	7/16"				X		
#RVL60	1/2"				X	X	

Antirouille / Rust free						
#00	3/16"	X		X	X	
#0	1/4"	X		X	X	X
#1	5/16"				X	X
#2	3/8"	X			X	X
#3	7/16"	X			X	X
#4	1/2"	X			X	X
#5	5/8"				X	X



Voir section **Outils** pour la pose d'œillets
See **tooling** section to install grommets.

RIVETS

Toutes nos pièces sont vendues séparément par sac de 100, 1 000, 5 000 ou 10 000. Choisissez la hauteur, en fonction de l'épaisseur du cuir.

COMBINAISONS POSSIBLES ENTRE TOUTES LES TÊTES #33-34-36 ET POTEAUX #P33, #P34 ou #P36 DE N'IMPORTE QUELLE HAUTEUR.

À NOTER QUE LA TÊTE #32 SE COMBINE EXCLUSIVEMENT AVEC LE POTEAU P32.

All pieces are sold separately by bag of 100, 1 000, 5 000 or 10 000. Choose the height, according with the thickness of the leather. You can match the Cap 33-34 and 36 along with any post of any length. EXCEPT CAP 32 TO BE USE WITH POST 32.

TÊTES / CAP

Largeur/Width	Largeur/Width	O	OA	N	GM
	5 mm	X	X	X	X
#33	7 mm	X	X	X	X
#34	9 mm	X	X	X	X
#36	11 mm	X	X	X	X

TIGES AVEC TROU / POST WITH HOLE

Largeur/Width	Hauteur/Height	O	OA	N	GM
	6 mm	X	X	X	X
P338	8 mm	X	X	X	X
P339	9 mm	X	X	X	X
P3310	10 mm	X	X	X	X
P3312	12 mm	n/d	n/d	n/d	n/d
P368	8 mm	n/d	n/d	n/d	X
P369	9 mm	n/d	n/d	n/d	n/d
P3610	10 mm	X	X	X	X
P3612	12 mm	X	X	X	n/d

TIGES AVEC CAPUCHON / POST WITH CAP

Largeur/Width	Hauteur/Height	O	OA	N	GM
	6 mm	X	X	X	X
P338_-2T	8 mm	X	X	X	X
P339_-2T	9 mm	n/d	X	X	n/d
P3310_-2T	10 mm	n/d	n/d	n/d	n/d
P3312_-2T	12 mm	n/d	n/d	n/d	n/d
P348_-2T	8 mm	n/d	X	X	X
P349_-2T	9 mm	X	X	X	X
P3410_-2T	10 mm	X	X	X	X
P3412_-2T	12 mm	n/d	n/d	n/d	n/d
P368_-2T	8 mm	n/d	n/d	n/d	n/d
P369_-2T	9 mm	n/d	n/d	n/d	n/d
P3610_-2T	10 mm	X	X	X	X
P3612_-2T	12 mm	n/d	n/d	n/d	n/d

CHARTE DE COULEURS

Les couleurs réelles peuvent différer / Actual colors may differ.



2T
Tige avec capuchon
Post with cap
(double tête/Double head)
Finition belle des 2 côtés. /
Beautiful finish on both sides.

RIVETS DIVERS / VARIOUS RIVET

VIS RIVET CHICAGO / CHICAGO SCREW-RIVET

	Quantité	Laiton/Brass	Acier inox./Stain. Steel	Nickel sur laiton/Nickel on brass	Gun Metal
1/4"	10	1290-01	N/D	1290-02NB	1290-64
	100	1290-11	N/D	1290-12NB	N/D
3/8"	10	1291-01	N/D	1291-02	N/D
	100	1291-11B	N/D	1291-12	N/D
1/2"	10	N/D	1293-SS	N/D	N/D
	100	N/D	N/D	1293-12	N/D



PIOLINO / SCREWED BUTTON STUDS - Vendu à l'unité / Sold by one



RV601 - Sac de 1000 / Bag of 1000
Rivets tubulaires plaqués zinc/
Tubular rivets zinc plated.
Grandeurs de / Lengths of: 1/4", 5/16",
3/8", 7/16", 1/2", 9/16".



RC9 - Boîte de 1 lb / 1 lb box.
Rivets en cuivre # 9 / #9 copper rivets
1/2", 5/8", 3/4", 1", 1-1/4", 1-1/2"
RC9-R
Rondelles en cuivre pour rivet # 9/
#9 Copper washer rivets.



Voir section **Outils** pour la pose de rivets
See **tooling** section to install rivets.

NYLON OU ACÉTAL? QUELLE EST LA DIFFÉRENCE? / NYLON OR ACETAL? WHAT IS THE DIFFERENCE?

NYLON: Le plus utilisé pour des conditions d'utilisation normales. Matériau léger, résistant au feu, doux au toucher. Peut se fragiliser sous des conditions de froid extrême. / *The most used for normal use conditions. Light weight material, fire resistant, soft to the touch. May become brittle under extreme cold conditions.*

Acétal: Matériau très rigide, résistance accrue à la traction, fonctionne bien dans des conditions de gel ou arides. / *Acetal: stiffness, tensile strength, performs well under freezing or arid conditions.*



SÉRIE F SERIE

Boucle d'ajustement lateral / *Side-released buckle*

- F34** 3/4" nylon noir / *nylon black*
- F34-BL** 3/4" nylon blanc / *nylon white*
- F1** 1" Noir / *Nylon black*
- F1DA** 1" double acétal noir / *double acetal black*
- F125** 1-1/4" acétal noir / *acetal black*
- F15** 1-1/2" nylon noir / *nylon black*
- F15D** 1 1/2" double nylon, noir / *double nylon black*



SÉRIE CAM SERIE

Boucle à levier / *Lever buckle*

- CAM34** 3/4", noir / *black*
- CAM1** 1" noir / *black*
- CAM15** 1-1/2" noir / *black*
- CAM2** 2" noir / *black (sur commande/on request)*



Attache pour casque de hockey / *Hockey helmet fasteners*

- AC1-NR** 1" noir / *black*
- AC58-BL** 5/8" blanc / *white*
- AC58-NR** 5/8" noir / *black*



SÉRIE F COURBÉE / CURVED F SERIE

Boucle d'ajustement lateral / *Side-released buckle*

- F58C-AC** 5/8" acétal noir / *acetal black*
- F2C** 2" noir / *black*
- F2CD** 2" 2 passants double, noir / *2 double slider, black*



SÉRIE MP SERIE

Mousqueton d'acetal / *Acetal snap hook*

- MP34** 3/4" noir / *black*
- MP1** 1" noir / *black*
- MP15** 1-1/2" noir / *black*
- MP2** 2" noir / *black*



SÉRIE FPD SERIE:

Passant double en nylon / *Double nylon slider*

- FPD38** 3/8" noir / *black*
- FPD34** 3/4" noir / *black*
- FPD1** 1" noir / *black*
- FPD1HD** 1" haute densité noir / *heavy duty, black*
- FPD1L** 1" large noir / *large, black*
- FPD125** 1-1/4" noir / *black*
- FPD15** 1-1/2" noir / *black*
- FPD15HD** 1-1/2" haute densité noir / *heavy duty, black*
- FPD2HD** 2" Acétal haute densité noir / *Acetal heavy duty, black*



FZP

Tirette acétal pour corde ou curseur noir / *Grouvy Zipper Pull black*



Passants à cordons en nylon / *Nylon cord locks*

- FPOPBA** Barrure boule ronde or antique / *Pop lock round antique gold*
- FPOPBN** Barrure boule ronde noire / *Pop lock round black*



SÉRIE FPS SERIE

Passant simple de nylon / *Single nylon slider*

- FPS34** 3/4", noir / *black*
- FPS1** 1", noir / *black*
- FPS125** 1-1/4", noir / *black*
- FPS15** 1-1/2", noir / *black*
- FPS2** 2", noir / *black*



FPOP12N

Passant à cordon en nylon nickel / *Cord lock in nylon, nickel*
Sac de 12/ *bag of 12.*



Passants à cordons en nylon / *Nylon cord locks*

- FPOPSN** Pop lock plat simple noir / *Barrel cord lock flat shape black*
- FPOPSA** or antique / *antique gold*



SÉRIE FTL SERIE

Glissière/ *Tension lock*

- FTL34-LISSE** 3/4", noir, pas de prise/ *No grip, black*
- FTL1** 1" noir / *black*
- FTL1M** 1" avec dent, noir / *with teeth, black*
- FTL15** 1-1/2", noir / *black*



Passants à cordons en nylon / *Nylon cord locks*

- FPIXISN** Barrure à ressort en nylon noir / *Cord lock nylon with plastic spring*



FCROC3

Crochet à mitanes 3 pièce / *Mittens hooks 3 pieces*

Sac de 100 pièces/ *Bag of 100 pieces*



La mesure indiquée est celle de l'intérieur /
The indicated measure is that of the interior



Mini mousquetons rotatifs pour sac à main.
Base ovale. / *Mini swivel snap hook for handbags. Oval loop base.*

AL169-80 1/2" (12,7 mm), or / gold
AL169-8A 1/2" (12,7 mm), or antique/
antique gold
AL169-8N 1/2" (12,7 mm), Nickel



Mini mousqueton rotatif base ovale. / *Small swivel snap hook oval base.*

Sac de 10 / 10 per bag

AL386-N 1/4" (6mm) Nickel



Mini mousqueton rotatif base ovale. *Small snap hook. Oval base.*

Sac de 10 / 10 per bag

AL388-N 9/32" (7mm), Nickel
AL388-A 9/32" (7mm), Or antique /
Antique gold



Mini mousquetons rotatifs pour sac à main.
Base ronde ou ovale. *Small swivel snap hook either round or oval loop base for handbags*

AL169-12A 1/2" (12,7 mm), Antique
AL169-12N 1/2" (12,7 mm), Nickel
AL169-34EB 3/4" (19 mm) Noir oxyde/
Black oxyde



Mini mousqueton rotatif base ronde. *Small snap hook round base nickel.*
Sac de 12/ 12 per bag.

AL389N 1/2" (12mm), Nickel



Petits mousquetons rotatifs à base carrée pour sac à main. / *Small swivel snap hooks flat loop for handbags*

AL170-12N 1/2" (12,7 mm), Nickel
AL170-34A 3/4" (19 mm), Or antique /
Antique gold
AL170-340 3/4" (19 mm), Or/Gold
AL170-34N 3/4" (19 mm), Nickel
AL170-1N 1" (25,4 mm), Nickel
AL170-15N 1 1/2" (38 mm), Nickel



Mousqueton rotatif base carrée. / *Flat base swivel snap hook.*

AL171-34N 3/4" (19 mm), Nickel
AL171-1A 1" (25,4 mm), Or antique/
Antique gold
AL171-10 1" (25,4 mm) Or/Gold
AL171-15N 1 1/2" (38 mm), Nickel
AL171-150 1 1/2" (38 mm), Or/Gold
AL171-15A 1 1/2" (38 mm), Or antique/
Antique gold



Mousqueton rotative à bourse./
Flat base swivel snap hook.

AL178-12N 3/4" (19 mm), Nickel



Mousqueton rotative base plate. /
Flat hook swivel snap hook

AL387 3/4" (19 mm), Nickel



Mousqueton rotatif oeil de bœuf, base plate./
Flat base swivel snap hook.
Jusqu'à épuisement/until quantity lasts.

AL476 3/4" (19 mm), Nickel



Mousqueton rotatif pour sac (fort). /
Strong swivel snap hook for bag.

AL182N 1 1/2" (38 mm), Nickel



Mousquetons rotatifs, forts, à base carrée. /
Strong swivel snap hook, square flat base.

AL 220-12N 1/2" (12,7 mm), Nickel
AL 220-34N 3/4" (19 mm), Nickel
AL 220-34AB 3/4" (19 mm), Antique
AL 220-10N 1" (25,4 mm), Nickel
AL 220-16AB 1" (25,4 mm), Laiton antique
/Antique brass



Mousqueton 2" rotatif, nickel. / *Swivel snap hook*

AL577-32N 2" (50,8 mm), nickel



Petit mousqueton ciseau rotatif. / *Small swivel scissor snap hook*. Sac de 10/Bag

AL5010N-1N 1" (25,4 mm), nickel



Oval

Mousqueton fort rotatif. / *Heavy duty swivel snap hook*.

OVALE/OVAL

AL225-38N 3/8" (9,5 mm) nickel / *nickel*

AL225-12B 1/2" (12,7 mm), laiton/brass

AL225-12B-LEGER 1/2" (12,7 mm), léger, laiton/light, brass

AL225-12N-COURT 1/2" (12,7 mm), 2 1/4" long nickel / 2 1/4" long nickel

AL225-12N-LEGER 1/2" (12,7 mm), léger, nickel / light, nickel

AL225-58B 5/8" (15,8 mm), laiton / brass

AL225-58C 5/8" (15,8 mm), chrome

AL225-34C 3/4" (19 mm), chrome

AL225-34N 3/4" (19 mm), nickel / *nickel*

AL225-1BR 1" (25,4 mm), laiton / brass

AL225-1SS 1" (25,4 mm), inox / *stain. steel*



Plat

PLAT /FLAT

AL225-34B 3/4" (19 mm), laiton / brass

AL225-1B 1" (25,4 mm), laiton / brass



AL3014

Mousqueton à porte-clés rotatif. / *Key holder swivel snap hook*.

AL3014-16N 5/8" (15,8 mm), nickel

AL3014-12N 3/4" (19 mm), nickel



Mousqueton à porte-clés rotatif. / *Key holder swivel snap hook*.

AL272-8 1/2" (12,7 mm), nickel



Mousqueton rotatif à porte-clés. / *Key holder with spring and swivel*.

Sac de 100 / Bag of 100

10650 15/16" (24 mm), nickel

10655 1" (27 mm), nickel

10660 1-1/4" (32 mm), nickel



Mousqueton décoratif avec chaînette et pince à griffes pour pompon ou ruban. 15 X 9 mm.

Key chain Lobster trigger with ribbon cord end. Sac de 10. / Bag of 10.

26010817 or/gold

26010817-01 nickel



Gros mousqueton ciseau rotatif. / *Large swivel scissor snap hook*.

OVALE OBLONG / OVAL

AL5014N-716N 1/2" (12,7 mm), nickel/nickel

PLAT /FLAT

AL5015-58N 5/8" (15,8 mm), nickel sur laiton / nickel on brass

AL5015-34B 3/4" (19 mm), laiton sur laiton / brass on brass

AL5015-34N 3/4" (19 mm), nickel sur laiton / nickel on brass

AL5015-1N-HR 1" (25,4 mm), nickel/nickel

AL5015-1AD 1" (25,4 mm), Antique sur laiton/Antique on brass

AL5015-1NPR 1" (25,4 mm), nickel sur laiton / nickel on brass

AL5015-1BPR 1" (25,4 mm), laiton sur laiton jusqu'à épuisement /brass on brass until quantities last

AL5014-N



AL5015-N



AL5015-1N-HR



AL5015-1AD



AL5015-1NPR



Mousqueton décoratif avec chaînette et pince à griffes pour pompon ou ruban. 18 X 17 mm.

Key chain Lobster trigger with ribbon cord end. Sac de 10. / Bag of 10.

26010818 Or, grosse pince / Gold Big Lobster trigger

26010818-01 Nickel grosse pince / Nickel big Lobster trigger



Mousqueton pour courroies ou clefs. /
Snap hook for keys or straps.

AL7261N 3/4" (19 mm) nickel



Mousqueton fort. / Strong snap hook

AL 142-34N 3/4" (19 mm), nickel
AL 142-1N 1" (25,4 mm), nickel
AL 142-15N 1 1/2" (38 mm), nickel
AL 142-2N 2" (50,8 mm), nickel



Mousqueton fort, pour ceinture de pompier. /
Strong sling snap hook (firefighters)

AL141-24N 1 1/2" (38 mm), nickel



Mousqueton plat à chaps / Flap chaps snap
hook

AL290-34B 3/4" (19 mm), laiton / brass
AL290-1N 1" (25,4 mm), nickel sur laiton /
nickel on brass



Mousqueton base, tige plate. / Squared base
snap hook, flat prong.

L-90544 3/8" (9,5 mm)
or antique / antique gold



Mousqueton plat à ressort, tige plate avec
anneau en D assorti. / Flat snap with spring,
large prong with assorted D ring

L-1A0059 7/8" (22,2 mm), gun metal



Mousquetons forts, à licou ou autre. / Heavy
duty snap hook (halter or other).

Z3726-75B 3/4" (19 mm), laiton/brass
Z3726-75SS 3/4" (19 mm), acier inox./
Stainless steel
Z3726-1N 1" (25,4 mm), nickel
Z3726-1B 1" (25,4 mm), laiton/brass



Mousqueton à harnais métal estampillé, tige plate
Harness stamped (drop forged) halter snap, flat
prong

Z3727-34N 3/4" (19 mm) nickel
Z3727-34B 3/4" (19 mm) laiton / brass
Z3727-1N 1" (25,4 mm), nickel
Z3727-1B 1" (25,4 mm), laiton /
brass



Mousqueton plat forgé pour harnais. /
Heavy stamped halter snap.

AL290-1SNP 1" (25,4 mm), plaqué nickel/
nickel plated
AL290-1SBP 1" (25,4 mm), plaqué laiton /
brass plated



Mousqueton à 2 crochets 3 1/2", long. /
Double headed snap hook 3 1/2" long





AL226-2N Nickel















BOUCLES DOUBLES / CENTRAL BAR BUCKLES

Boucles pour soulier / Shoe buckles

À GLISSIÈRE- SLIDER		À ROULEAU - WITH ROLLER		
				
Boucle à glissière pour soulier de danse. / Dance shoe slider buckle. S2952N 3/16" nickel S2952A 3/16" or antique / antique gold S2953N 1/4" nickel S2953NR 1/4" noir / black S2965 7/16" doré / gilt S2964N 1/2" nickel S2964NR 1/2" noire / black S2963 5/8" nickel		S2957GM 1/4" gun metal S2957N 1/4" nickel S29570R 1/4" or / gold S2961 1/2" or / gold S2995A 1/2" or antique / Antique gold S2970R 3/8" or / gold S297GM 3/8" gun metal S2962 5/8" nickel		
MINI BOUCLE- MINI BUCKLE		DOUBLE BARRE - DOUBLE BAR		SANS ROULEAU / WITHOUT ROLLER
				
S40D 5/16" dorée / gilt S40N 5/16" nickel S3002 5/16" or / gold		Avec rouleau / With roller S2956N 1/2" nickel S2956NR 1/2" noir / black S29560R 1/2" or / gold S2968N 5/8" nickel Sans rouleau / Without roller S3000D 5/16" or / gold		S2959 1/2", or / gold. S2960 1/2", or / gold. C290 5/8", nickel.

BOUCLES DOUBLES / CENTRAL BAR BUCKLES

Pour sac, courroies ou autres / For bag straps or other

 <p><i>Coup de cœur</i></p>	 <p><i>Coup de cœur</i></p>	 <p><i>Coup de cœur</i></p>	 <p><i>Coup de cœur</i></p>
<p>Boucle double à rouleau. / Central bar roller buckle.</p> <p>AL2569-8A 1/2" or antique / antique gold AL2569-8N 1/2" plaqué nickel / nickel plated AL2569-10A 5/8" or antique / antique gold AL2569-10N 5/8" nickel AL2569-12A 3/4" or antique / antique gold AL2569-12N 3/4" plaqué nickel / nickel plated AL2569-16A 1" or antique / antique gold AL2569-16N 1" nickel</p> <p>MINIMUM 12</p>	<p>BK58A 3/8" or antique / antique gold BK58GM 3/8" gun metal BK58N 3/8" nickel BK92A 1/2" antique / antique gold BK92GM 1/2" gun métal BK92N 1/2" nickel BK93A 9/16" or antique / antique gold BK93GM 9/16" gun metal BK93N 9/16" nickel BK10A 3/4" or antique / antique gold BK10GM 3/4" gun métal BK10N 3/4" nickel</p> <p>MINIMUM 12</p>	<p>C4350N 3/4" nickel C4350A 3/4" antique C4350GM 3/4" gun metal</p> <p>MINIMUM 12</p>	<p>AL455-1N 1" nickel AL455-10 1" or / gold AL455-1A 1" antique AL455-1GM 1" gun metal AL455-125N 1 1/4" nickel</p> <p>MINIMUM 6</p>
			
<p>C4666N 3/4" nickel</p>	<p>AL454-24AB 1-1/2" or antique / antique gold</p> <p>MINIMUM 6</p>	<p>L-006 1-1/2" nickel satiné / satin nickel</p> <p>MINIMUM 6</p>	<p>L-ET7071 1" nickel satiné / satin nickel</p> <p>MINIMUM 6</p>
			
<p>C5062 1" electro nickel</p> <p>MINIMUM 6</p>	<p>AL40-1N Boucle double tout usage 1" nickel sur zinc (faux rouleau). / 1" double buckle nickel on zinc.</p>		

RÉGULIÈRES / REGULAR



BOUCLES SIMPLES / END BAR BUCKLES

				
AL392-8A 1/2" or antique <i>antique gold</i> AL392-8NP 1/2" nickel	C4742A 5/8" laiton antique/ <i>antique brass.</i>	C4463N 5/8" nickel C4463O 5/8" laiton lustré / <i>high gloss brass</i>	AL392-12A 3/4" or antique <i>antique gold</i> AL392-12NP 3/4" nickel	C5054 3/4" or / <i>gold.</i>
				
EXCLUSIVE C5003G 3/4" or / <i>gold</i> C5003N 3/4" electro nickel	AL392-16A 1" antique AL392-16NP 1" nickel	C5040 1" nickel brossé / <i>brushed nickel</i>	U41 1" or antique / <i>antique gold</i>	C5746N 1-1/8" nickel
				
U20A 1-1/8" or antique/ <i>antique gold</i> U20NA 1-1/8" nickel antique	C55402-A 1-1/8" or antique / <i>antique gold (M3)</i> C55402-O 1-1/8" or / <i>gold (M3)</i>	C5664A 1-1/4" antique C5664N 1-1/4" nickel	C5063 1-1/4" argent brossé/ <i>brushed nickel</i>	U27N 1-1/4" nickel U27O 1-1/4" or / <i>gold</i>
				
C405 1-3/8" nickel	L-ET7826 1-3/8" laiton / <i>brass</i>	U90 1-3/8" argent brossé/ <i>brushed nickel</i>	U152N 1-3/8" nickel	U152OR 1-3/8" or / <i>gold</i>
				
AL1125N 1-1/2" electro nickel AL1125GM 1-1/2" Gun metal	C5184A 1-1/2" or antique / <i>antique gold</i>			

BOUCLES À ROULEAU / ROLLER BUCKLES

	 Faux rouleau/False roller			
C227 1" argent brossé / brushed nickel	BR1SN-1X1 1" nickel satiné / satin nickel	C247 1-1/8", nickel	C218 1-1/4" or antique / antique gold	C252 1- 1/4" nickel antique
				
C5004 1-1/4" laiton / brass	C226 1-1/4" argent satiné / satin nickel	2 tiges. / 2 prongs. C5014 1-3/8" antique nickel	L-003 1-1/2" nickel antique / antique nickel	C7019 1-5/8" electro nickel
				
BR12N 1/2" nickel BR58A 5/8" or antique/ antique brass BR58N 5/8" nickel BR34N 3/4" nickel fine BR34X58N 3/4" nickel BR34A 3/4" or antique/ antique gold BR1A 1" or antique / antique gold BR1SN 1" nickel satiné / satin nickel BR125N 1-1/4" nickel BR138N 1-3/8" nickel BR15N 1-1/2" nickel BR15NF 1-1/2" forte nickel / heavy duty BR15LN 1-1/2" légère nickel / light BR158NF 1-5/8" Forte nickel / Heavy duty BR175NF 1- 3/4" nickel BR2NF 2" forte nickel / heavy duty BR2FN-L 2" large tige nickel / Large prong	Soudée / Welded. AL720-12 3/4" nickel AL720-16 1" nickel AL720-18 1-1/4" nickel AL720-20 1-1/2" nickel AL720-24 1-1/2" nickel grosse tige/ oblong prong AL720-134 1-3/4" nickel AL720-32 2" nickel	2 tiges. / 2 prongs. FORTE / HEAVY DUTY BR15NF-2P 1-1/2" nickel BR175NF-2P 1-3/4" nickel BR2NF-2P 2" nickel AL720-32 2" nickel RÉGULIÈRE / REGULAR BR25N-2P 2-1/2" nickel	BR25N-3T 2" nickel	Soudé 2 tiges. / 2 prongs, welded. AL720-32-2P 2" nickel

BOUCLES À ROULEAU / ROLLER BUCKLES

		
<p>Moulée / Casted - MINIMUM 12</p> <p>AL2423-10 1/2" forte, nickel/ 1/2" heavy duty, nickel</p> <p>AL2423-11 5/8" nickel</p> <p>AL2423-12C 3/4" chrome (importé)/ 3/4" chrome (imported)</p> <p>AL2423-16 1" forte, plaqué, nickel/ 1" heavy duty, nickel plated</p> <p>AL2423-16L 1" forte, longue, nickel/ 1" heavy duty, long, nickel</p>	<p>Longue / Long. - MINIMUM 12</p> <p>AL2523-12LSS 3/4" inox / Stain. steel</p>	<p>Forte / Strong - MINIMUM 12</p> <p>AL2570-12N 3/4" plaqué nickel / plated nickel</p> <p>AL2570-16A 1" or antique / antique gold</p> <p>AL2570-16N 1" nickel /nickel</p>

BOUCLES FORTES POUR HARNAIS/ STRONG HARNESS BUCKLES

			
<p>Boucle Conway / Conway buckle MINIMUM 6</p> <p>AL545W34B 3/4" laiton / brass</p> <p>AL545W34N 3/4" nickel</p>	<p>Boucle Conway./ Conway buckle. MINIMUM 6</p> <p>AL106W58B 5/8" laiton / brass</p> <p>AL106W58SS 5/8" Inox /stain.steel</p> <p>AL106W34B 3/4" laiton / brass</p> <p>AL106W34C 3/4" chrome</p> <p>AL106W1C 1" chrome</p>	<p>Boucle à harnais double, fortes / Halter central bar buckle. MINIMUM 6</p> <p>AL520-12SS 1/2", inox/ stain. steel</p> <p>AL520-12B 1/2", laiton / brass</p> <p>AL520-58B 5/8", laiton / brass</p> <p>AL520-58SS 5/8", inox. / stain.steel</p> <p>AL520-34B 3/4", laiton / brass</p> <p>AL520-34SS 3/4", inox / stain. steel</p> <p>AL520-1B 1", laiton / brass</p> <p>AL520-1N 1", nickel</p> <p>AL520-1SS 1", inox / stain. steel</p> <p>AL520-15B 1 1/2", laiton / brass</p> <p>AL520-15N 1 1/2", nickel</p> <p>AL520-15SS 1 1/2, inox. / stain.steel</p> <p>AL520-175SS 1 3/4" inox / stain. steel</p>	<p>Boucle double barre / Double bar buckle. MINIMUM 6</p> <p>CM114-34SS 3/4" inox / stain. steel</p> <p>CM114-1BP 1" plaquée laiton / brass plated</p> <p>CM114-1SS 1" inox / stain. steel</p>

POUR D'AVANTAGE DE MODÈLES [CLIQUEZ ICI](#)
SEE MORE BUCKLES [CLIC HERE](#)

ANNEAUX RONDS / O RINGS

**Meilleur vendeur!
Best seller!**

			
<p>Série DR - SAC DE 100 / BAG Anneaux pour porte-clés. <i>Split key ring chain.</i> 8, 20, 24, 25, 28, 30, 34 mm. Or ou nickel. / <i>Gold, nickel.</i></p>	<p>DR32MMP-N - SAC DE 100 / BAG Anneau plat de luxe pour porte-clés. / <i>Large split key ring chain.</i> 32 mm, nickel.</p>	<p>Série ORS - SAC DE 12 / BAG sauf / <i>except 1/2" Sac/Bag of 100.</i> Anneaux soudés, <i>O welded ring.</i> Nickel : 1/2", 5/8", 3/4", 1", 1 1/4", 1 1/2", 1 3/4", 2". Or antique/<i>antique gold</i> : 1", 1 1/4", 1 1/2", 1 3/4", 2".</p>	<p>Série ORC - SAC DE 12 / BAG Anneaux ronds moulés en laiton / <i>O ring casted in brass</i> 3/4", 1", 1 1/4", 1 1/2" Sur demande / <i>On request</i> : 1 3/4" et/and 2" Disponible en nickel 3/4" et 1" <i>Available in nickel 3/4" and 1"</i></p>

ANNEAUX MOULÉS / CASTED O RINGS • LOTS EN QUANTITÉ LIMITÉES - LIMITED QUANTITIES (SAC DE 12 / BAG) :

			
<p>L026 Anneau, gun métal, 3/4". <i>O ring, gun metal, 3/4".</i></p>	<p>L028 Anneau, or, 3/4". <i>O ring, gold, 3/4".</i></p>	<p>L031 Anneau, nickel 5/8". <i>O ring, nickel, 5/8".</i></p>	<p>L-B14409R Anneau rond moulé 1 1/2" gauge 6mm nickel, Pour ceinture ou Bourse. <i>Oring molded 1 1/2" gauge 6mm.</i> <i>For belt or purse.</i></p>



QUINCAILLERIE / HARDWARE

ANNEAUX EN D / D RINGS (SAC DE 12 / BAG) :



Série D • Anneaux en D non soudés / Non Welded D Rings

Anneaux en D. D ring.

**Meilleur vendeur!
Best seller!**

	3/8"	1/2"	5/8"	3/4"	7/8"	1"	1 1/4"	1 1/2"	2"
Nickel	X	X	X	X	X	X	X	X	X
Or / Gold	X	X	X			X	X		
Or antique / Antique gold	X	X	X	X	X	X	X	X	
Noir antique / black			X						
Gun métal / Gun metal						X			



Série DS • Anneaux en D soudés / Welded D Rings

Léger / light ± 2 mm • Lourd / heavy ± 5 mm

**Meilleur vendeur!
Best seller!**

	1/2"	5/8"	3/4"	1"	1-1/8"	1 1/4"	1 1/2"	1 3/4"	2"
Nickel léger / light	X	X	X	X		X	X		X
Nickel lourd / heavy			X	X	X		X	X	X
Or antique / Antique gold léger / light				X					

ANNEAUX EN D MOULÉS / CASTED D RINGS • LOTS EN QUANTITÉ LIMITÉES - LIMITED QUANTITIES (SAC DE 12 / BAG) :

L-BR0024 Passant doré / Gold loop, 1/2".	L-024 D ring, nickel 5/8".	L-025 D ring, nickel 3/4" X 5/8".	L-021 D ring, nickel brossé / Brushed nickel 1 3/8" X 7/8".
L-022 D ring, nickel brossé / Brushed nickel 1 3/8".	L-023 D ring, laiton / brass 1 3/8".	L-046 D ring, nickel ou or / nickel or gold. 1 7/16".	L-018 et L-017 D ring, nickel antique 1 1/2".
L-020 D ring, gun metal, 1 1/2" X 1 3/16".			

PASSANTS RECTANGULAIRES OU CARRÉS / RECTANGULAR OU SQUARE LOOPS





Série W3R Serie

Passants rectangulaires pour bourse / Single loop for purse.







**Meilleur vendeur!
Best seller!**

	5/8"	3/4"	7/8"	1"	1 1/4"	1 1/2"	2"
Nickel	X	X	X	X	X	X	X
Or /Gold	X	X					
Or antique/ Antique gold	X	X		X	X	X	
Gun metal				X			





	
<p>Série PO Serie Passant oval pour bourse. <i>Oval shape loop for purse.</i></p> <p>P034A 3/4" or antique/ antique gold P034N 3/4" nickel P01A 1" or antique/ antique gold P01N 1" nickel P0125A 1-1/4" or antique/ antique gold P0125N 1-1/4" nickel</p>	<p>Série REC Serie Passant rectangulaire plat pour bourse. <i>Flat rectangular loop for purse.</i></p> <p>REC34A 3/4" or antique / antique gold REC34N 3/4" nickel REC1A 1" or antique / antique gold REC1N 1" nickel REC15A 1-1/2" or antique / antique gold REC15N 1-1/2" nickel REC2A 2" or antique / antique gold REC2N 2" nickel</p>



LOTS EN QUANTITÉ LIMITÉES - LIMITED QUANTITIES

			
<p>L-039 Rectangle, nickel 5/16" X 7/16".</p>	<p>L-038 Rectangle, nickel 1" X 3/4".</p>	<p>L-040 Rectangle, nickel brossé / <i>brushed nickel.</i> 1" X 3/4".</p>	<p>L-043 Rectangle, gun metal. 1" X 3/4".</p>
			
<p>L-037 Rectangle, gun metal. 1 5/16" X 1".</p>	<p>L-035 Rectangle, nickel. 1 1/2" X 2 3/8".</p>	<p>L-036 Rectangle, nickel antique/<i>antique nickel.</i> 2" X 1 1/4".</p>	

PASSANTS / LOOPS

			
<p>Série AL177 Serie Passant rectangulaire avec coulisse pour courroie. / Rectangular loop with slider for straps.</p> <p>AL177-12A 1/2" or antique / antique gold AL177-12N 1/2" nickel AL177-1A 1" or antique / antique gold AL177-1N 1" nickel AL177-1GM 1" gun metal AL177-125A 1-1/4" or antique / antique gold AL177-125N 1-1/4" nickel AL177F-125A 1-1/4" or antique / antique gold AL177F-125GM 1-1/4" gun metal AL177-15A 1-1/2" or antique / antique gold AL177-15N 1-1/2" nickel</p>	<p>Série AL541 Serie Passants doubles à forme arrondie. / Double round shape loops.</p> <p>AL541-34N 3/4" nickel AL541-1N 1" nickel AL541-125N 1-1/4" nickel AL541-15A 1-1/2" antique AL541-15N 1-1/2" nickel AL541-134N 1-3/4" nickel AL541-2A 2" antique AL541-2N 2" nickel</p>	<p>Passants doubles plats pour attaches à tablier, nickel / Flat double loops for apron fasteners, nickel.</p> <p>W305 3/4" W310 1" W312 1 1/4" W315 1 1/2" W320 2"</p>	<p>Attaches pour tablier, 2 parties incluses / Apron fastener, 2 parts included</p> <p>W340 1", nickel W325 1-1/4", nickel, noir / black W330 1-1/2", nickel W335 2", nickel, or antique / antique gold</p>

ATTACHES / CLIPS

				
<p>Attache pour bretelles, passant rond, nickel. / Suspender clip round slider nickel. (min 12).</p> <p>W2-15PR 1 1/2" W2-2PR 2"</p>	<p>Attache pour bretelles, argent/ nickel. / Suspender clip nickel. (min.12)</p> <p>W189-50 1/2 " W189-34 3/4 " W189-1 1 " W189-150 1 1/2"</p>	<p>W190 (min. 12) Ajusteur à bretelles, 1 ", plaqué nickel. / Adjuster with braces nickel plated.</p>	<p>Ajusteur à peau de mouton. nickel. / Adjustable slider for sheepskin, nickel. (min. 12)</p> <p>W10-15 1 1/2" W10-2 2"</p>	<p>AL404-1 Boucle à griffe T buckle, 1"/ 1" Squeeze buckle nickel plated.</p>
				<p>SAC DE 100 100 PER BAG</p>
<p>1239-00 Pince pour ceinture 1 3/4", nickel. / Universal spring holster clip nickel. 3 1/2" X 7/8"</p>	<p>1354-F2 (min. 12) Pince 3 1/4" X 7/8" pour ceinture 2", noir. / Metal belt clips 2", black.</p>	<p>AI 837-AZP Plaque à ceintures, zinc à 2 crochets 2 1/4 X 5/8", nickel. / 2 hooks plate for belt in zinc.</p>	<p>Plaque avec anneau en D/ D ring with clamp.</p> <p>DW7285A or antique / antique gold DW7285GM gun metal DW7285N nickel DW7285NR noir / black DW7285OR or / gold</p>	

FERMOIRS À SACS / BAG CLASPS

				
		<p>W77450 (min.12) Attache à bourse rotatif, argent. / Swivel purse lock nickel. 1" X 3/4"</p>	<p>W3109 (Sac de 10/per bag) Fermoir à 2 rivets 7/8" (3 pièces) nickel sur laiton (moto, bateau)/ Dot fasteners 7/8" with 3 pieces nickel on brass (moto, boating)</p>	<p>P-2212-A Fermoir à bourse (4 parties) laiton antique/ Luxury turn lock for purse (4 parts) Antique brass. 1 1/4" x 11/16"</p>
				
<p>P-2376- Fermoir luxueux à bourse (3 parties) / Luxury turn lock for purse (3 parts). 1 1/4" x 7/8". A laiton antique / antique brass O or / gold N nickel</p>	<p>P-2210- Fermoir à bourse luxueux (4 parties). / Luxury turn lock for purse (4 pieces). 1 1/2" X 1" A laiton antique / antique brass N nickel O or / gold</p>	<p>P-2469-0 Fermoir à bourse (4 parties) Or / Laiton antique. / Luxury turn lock for purse (4 parts) Gold / Antique brass. 1 3/8" X 3/4"</p>	<p>W7748 Fermoir doré à pression (4 parties). / Snap fastener for purse in gold (4 parts). 1" X 1/2".</p>	

BOUTONS FERMOIRS À SACS / BAG CLASPS BUTTONS

		
<p>P-3080-N Bouton fermoir à bourse nickel avec trou laissant passer une courroie de 5/8" x 1/4" d'épaisseur. Joli élément pour sacs. Purse fastener with strap opening (5/8" large x 1/4" thick). Nice design to enhance beauty of clutch hand bag.</p> 	<p>MR5 (min 12) Bouton rond avec fermoir aimanté pour sacs à main 1/2" ou 3/4". (4 parties). Or, or antique ou nickel / Round purse magnet for bags (4 parts) in 1/2" or 3/4". Gold, antique gold or nickel.</p> 	<p>MR-50 (min 12) Aimant extra fort rond pour étui ou sac de cuir. / Round extra strong magnetic snap for holster or leather bags.</p> <p>Diamètre / Diameter : 1/4", 3/8", 1/2", 3/4", 1"</p> <p>Pour tous les diamètres, épaisseur de 1/16". L'épaisseur de 1/8" est aussi disponible pour le 3/4". For all diameters, thickness of 1/16". Thickness of 1/8" also available for 3/4" diameter.</p>

QUINCAILLERIE / HARDWARE

ACCESSOIRES POUR SAC À MAIN / PURSE ACCESSORIES

			
C-1847 (Sac de 12 / per bag) Petit passant à cordon nickel pour cordon 1/8". / <i>Small pop lock nickel, for 1/8" lace.</i> 3/8" x 3/8"	C-1805 (Sac de 12 / per bag) Passant à cordon nickel pour cordon env. 3/16". / <i>Pop lock nickel for lace around 3/16".</i> 1" x 1/2"	C-1777-NIC (Sac de 12 / per bag) Passant à cordon nickel pour cordon 1/4". / <i>Round Pop lock nickel for lace around 1/4".</i> 1" x 1/2"	P-2276-NP (unité / unit) Bout de cordon env. 3/16" argent avec vis. / <i>Cord tip nickel for lace around 3/16" with screw.</i>

FERMOIRS À SACS D'ÉCOLE, COFFRES À CRAYONS... / SCHOOL BAG OR PENCIL CASE FASTENERS



				
L-1184A Fermoir à sac (4 parties) or antique. / <i>Tuck clutch lock (4 parts) antique gold.</i> 1 5/8" x 1 3/4"	L-2332 Fermoir à sac (4 parties) or antique. / <i>Tuck lock (4 parts) antique gold.</i> 3/4" x 1 1/4" A or antique brass BP plaqué laiton/brass plated	L-2331A Fermoir à sac. (4 parties) or antique. / <i>Tuck lock (4 parts) antique gold.</i> 1" x 1 1/4"	L-3405-A Fermoir à sac luxueux (4 parties) laiton antique. / <i>Luxury tuck lock (4 parts) antique brass.</i> 1" x 1 1/2"	
				
MR-4723 Fermoir à sac d'école, nickel. / <i>1" school bag lock nickel.</i> 1" X 1 3/4"	MR-11590B Fermoir économique à sac d'école. Couleur laiton 1" (4 parties). / <i>Economy school bag lock 1" brass plated (4 parts).</i>	MR-11591N Fermoir économique à sac d'école. Couleur nickel 1 1/4" (4 parties). / <i>Economy school bag lock 1 1/4", nickel plated (4 parts)</i>	MR-11592N Fermoir économique à sac d'école. Couleur nickel 1-1/2" (4 parties). / <i>Economy school bag lock 1-1/2" nickel plated (4 parts)</i>	L-2136 Fermoir de luxe à porte-documents, or antique 1 1/4" X 2" (4 parties). / <i>Tuck lock (4 parts), 1 1/4" X 2" antique brass.</i>

QUINCAILLERIE / HARDWARE

ACCESSOIRES POUR PORTE-FEUILLES/ ACCESSORIES FOR WALLETS







		
<p>VIN1 (Minimum 6) Livret de plastique à 8 compartiments, très résistant./ 8-compartment resistant plastic booklet</p>	<p>PAC (Minimum 6) Fermoir à porte monnaie 3 1/2" / Squeeze frame 3 1/2".</p>	<p>HU1N (Minimum 12) Pince à porte-billets 2 parties, nickel. / 2 pieces clip for moneyclip, nickel.</p>

FERRONNERIE / IRONWORKS

		
<p>W7 Tenseur à cliquet « Ratchet » 1". / 1" Tie down ratchet.</p>	<p>W9 (Minimum 12) Ecroû encastré à entailles, 1/4", vis en sus. 1/4" T-nuts, screw not included.</p>	<p>W4 (Minimum 6) Porte-gallon à mesurer. Nickel./ Metal measuring tape holder. Nickel.</p>









<p>W5 (Minimum 6) Porte-marteau./ Metal hammer holder.</p>



			
<p>Pyramide / Pyramid spots Nickel sur laiton (antirouille) / <i>Nickel on brass (rust free) :</i> MR-18410-B 1/2" MR-18412-B 1/4" MR129312-B 3/8" Nickel acier /steel : MR129312 3/8"</p>	<p>Cabochons ronds. / <i>Round spots:</i> 129222 5/16" acier nickel/steel MR-8024 1/4" acier nickel/steel MR-8024-C 1/4" chrome MR-8035 1/2" chrome MR-8036-C 3/4" chrome Antirouille nickel sur laiton./ <i>Rust free nickel on brass :</i> MR-8035-B 1/2" MR-8023-B 3/8"</p>	<p>Cabochons coniques. / <i>Conic spots.</i> Nickel acier / steel : MR-18420 1/2"</p>	<p>W6031 Clou décoratif carapace tortue, 1/2", or antique. / <i>Decorative 1/2" long turtle nail, antique gold.</i> Vendu à l'unité / <i>Sold by unit</i></p>
			
<p>AL195 Sous pied de bourse argent ou or / <i>Bell stud for purse nickel or gold.</i> Vendu à l'unité / <i>Sold by unit</i></p>	<p>L047 Chaîne / <i>Chain</i> <i>Quantité limitée / Limited quantity</i></p>		



ARTISANAT PREMIÈRES NATIONS / FIRST NATION CRAFTS PROJECTS

																										
<p>Os/Bones (Sac de/bag of 100)</p> <table border="1"> <thead> <tr> <th>Grosseur/Size</th> <th>Blanc/White</th> <th>Noir/Black</th> </tr> </thead> <tbody> <tr> <td>1/2"</td> <td>16900</td> <td>16907</td> </tr> <tr> <td>3/4"</td> <td>32131</td> <td>Quantité limité / Limited quantities</td> </tr> <tr> <td>1"</td> <td>16901</td> <td>16908</td> </tr> <tr> <td>1-1/2"</td> <td>16902</td> <td>16909</td> </tr> <tr> <td>2"</td> <td>16903</td> <td>16910</td> </tr> <tr> <td>3"</td> <td>16905</td> <td>16912</td> </tr> <tr> <td>4"</td> <td>16906</td> <td>-</td> </tr> </tbody> </table>	Grosseur/Size	Blanc/White	Noir/Black	1/2"	16900	16907	3/4"	32131	Quantité limité / Limited quantities	1"	16901	16908	1-1/2"	16902	16909	2"	16903	16910	3"	16905	16912	4"	16906	-	<p>15202 (1000 unités par sac/ 1000 units per bag) Billes bois 6 mm. / 6 mm wood beads. Couleurs disponibles/ Available colours :</p> <ul style="list-style-type: none"> 00 blanc/white 01 noir/black 04 bleu/blue 05 jaune/yellow 06 vert/green 08 naturel 09 brun moyen/med brown 10 acajou/mahogany 11 brun foncé/dark brown 12 violet 14 multi 19 turquoise 20 café/coffee 	<p>Série 21500 Series Anneau capteur de rêve plaqué or./ Dream catchers gold plated.</p> <p>Grandeur disponible / available size : 1-1/4", 1-1/2", 2", 2-1/2", 3", 4", 5", 6", 7", 8", 9", 10", 14", 16"</p> <p>Possibilité d'acheter à l'unité ou en paquet / Can be purchased by unit or pack.</p> <p>Sac de/bag of 100 : 1 1/4" à/to 6" Sac de/bag of 25 : 7" à/to 10" Pq't de/of 10 : 14" et plus /and more</p>
Grosseur/Size	Blanc/White	Noir/Black																								
1/2"	16900	16907																								
3/4"	32131	Quantité limité / Limited quantities																								
1"	16901	16908																								
1-1/2"	16902	16909																								
2"	16903	16910																								
3"	16905	16912																								
4"	16906	-																								
																										
<p>78003005-01h (3 plumes par sac / 3 feathers per bag) Plumes imitation d'aigle, blanc et à bout brun pâle 12" / Feathers Eagle imitation white tipped pale brown 12".</p>	<p>78003005-00h (3 plumes par sac / 3 feathers per bag) Plumes imitation d'aigle, blanc et à bout noir 12" / Feathers Eagle imitation white tipped black 12".</p>																									
 <p>22301001 22301001-01</p> <p>11353 11351</p>	<p>Pow wow regalias, cônes en aluminium argent/ Jingle cones, Aluminum silver:</p> <p>22301001 Modèle McPherson, embossé, 64 mm, paquet 25 McPherson pattern, embossed, 64mm, 25/pack</p> <p>22302001-01 Modèle Pow Wow tulipe, embossé, 64 mm paquet 25 Pow Wow tulip pattern, 64mm, 25/pack</p> <p>11353 Modèle régulier, lisse, 37mm, paquet de 100 Jingle regular, smooth, 37 mm, 100/pack</p> <p>11351 Modèle régulier, lisse, 29mm, paquet de 100 Jingle regular, smooth, 29 mm, 100/pack</p>																									



Voir section **fils et aiguilles à perler**
See **beading needles and threads** section to install button.

Artistic PROFESSIONNEL

PRODUITS POUR LE CUIR PRODUCTS FOR LEATHER CARE



Fait au Québec, Canada / Made in Quebec, Canada

UNE MARQUE DE CONFIANCE POUR TEINDRE LE CUIR / A TRUSTED BRAND TO DYE LEATHER

Teinture pour le cuir naturel.

Dye for russet tanned leather. (TA)

8 oz (250 ML), 32 oz (1L) et/and 1 gallon (4 L)



Teinture qui procure une excellente pénétration sur les cuirs de tannage végétale. Appliquer au vaporisateur ou à l'éponge en mouvement circulaire afin d'éviter les rayures. Une couche de finition est nécessaire afin d'éviter la décoloration.

(TA+ couleur + format)

Dye with excellent penetration on vegetal tanned leathers. Apply with sprayer or sponge in circular motions to prevent streaking. A finishing coat is necessary to help prevent discoloration.

(TA + color + size)

01 NOIR BLACK	09 TAN
03 BRUN FONCÉ DARK BROWN	10 ULTRAMARINE NAVY
05 BRUN LÉGER LIGHT BROWN	12 VERT GREEN
06 ROUGE FEU FLASH RED	13 ROUGE CERISE CHERRY RED
07 ROUGE CRAMOISIE CRIMSON RED	15 JAUNE CITRON LEMON
08 ORANGE	22 BRUN ROUGE RUSSET

Teinture pigmentée pour le cuir.

Pigmented Dye for Leather (TPIG)

8 oz (250 ML), 32 oz (1L) et/and 1 gallon (4 L)



Teinture opaque, flexible, permanente et durable pour le cuir. Peut être utilisée sur des objets endommagés comme des chaussures, des selles d'équitation, des fauteuils, etc. Appliquer au vaporisateur ou par léger tapotement avec une éponge. Répéter l'opération de deux à trois couches en laissant sécher entre les couches. Une couche de finition est nécessaire et un catalyseur pourrait l'être également.

(TPIG+ couleur + format)

An opaque, flexible, permanent and durable dye for leather. Can be used on damaged shoes, riding saddles, chairs, etc. Apply with sprayer or by patting with a sponge. Repeat for two to three coats, letting dry between coats. A finishing coat is necessary and catalyst might be too.

(TPIG+ color + size)

01 NOIR BLACK	12 VERT GREEN
03 BRUN CHOCOLAT CHOCOLAT BROWN	16 BLEU BLUE
13 ROUGE RED	18 BLANC WHITE
15 JAUNE OCRE YELLOW TAN	31 JAUNE PRIMAIRE PRIMARY YELLOW

Teinture à brodure lustrée

Glossy Edge Dye (TB)

8 oz et/and 32 oz



Teinture spécialement conçue pour les tranches du cuir sur vos produits de maroquinerie. Fini lustré. Appliquer avec un tampon de mouton ou au pinceau.

(TB + couleur + format)

A specially developed dye for leather sections of your leathercraft products. Glossy finish. Can be applied with a sheep swab or a brush.

(TB + color + size)

01 NOIR BLACK
04 BRUN CHOCOLAT CHOCOLAT BROWN

Les couleurs réelles peuvent différer / Actual colors may differ.

Artistic
PROFESSIONNEL



Fait au Québec, Canada / Made in Quebec, Canada

Couche de finition.

Finishing coat

8 oz (250 ML), 32 oz (1L) et/and 1 gallon (4 L)



2280 lustré / glossy

2281 mat / matte

2282 semi-lustré / semi-glossy

2283 fini pour blanc / for white dye

Protège et prolonge l'aspect du cuir. Après la teinture terminez en appliquant une couche de finition soit au vaporisateur, à l'éponge ou au linge en minces couches circulaires pour empêcher les rayures.

Protect and prolong the appearance of your leathers. After dyes, finish up by applying a finishing coat with a sprayer, a sponge or a cloth. Use small, circular motions to prevent streaking.

Catalyseur.

Catalyst

2 oz (50 ML)



Durcisseur pour couche de finition. Ajouter 5% par litre de finition.

Hardener for leather finish. Add 5% per liter of finish coat.

Crème polisseuse pour le cuir

Polishing cream for Leather

2 oz (50 ml)



CREME-NR
NOIR /BLACK

CREME-BM
BRUN MOYEN
MEDIUM BROWN

CREME-BN
BRUN FONCÉ
DARK BROWN

CREME-TN
TAN

CREME-MR
MARINE /NAVY

CREME-NT
NEUTRE/NEUTRAL

CREME-BG
BOURGOGNE
BURGUNDY

Crème auto-lustrante qui polit et nourrit tous les cuirs véritables et synthétiques instantanément (excepté le suède et le nubuck). Formule à base d'eau sans solvant. Ne nécessite aucun polissage. Tampon de mousse inclus dans le couvert.

Self polishing cream that nourishes and protects any type of leather as soon as it is applied (except suede or nubuck). Formula based on water without solvent. Requires no polishing. Foam pad included in the cover.

Teinture pour suède

Black suede dye
(TSUEDE-NR)

4 oz. (120 ml)



Teinture noire en vaporisateur spécialement formulée pour le suède et le nubuck. Conserve et prolonge la belle apparence du suède. Utiliser avec protecteur hydrofuge (Prohydro-8)

Black dye spray specially formulated for suede and nubuck. Refrain of prolongs the beauty of suede. Use with waterproof protector (Prohydro-8)

Soin professionnel du cuir

Professional leather care (HARTIS)

Nettoyeur 8 oz (250 ml), protecteur 8 oz et chiffon
Cleaner 8 oz (250 ml), protector 8 oz and cloth



Ensemble pour les meubles en cuir

Deux produits pour entretenir et protéger la beauté de vos meubles (fauteuils) ou articles de cuir préférés avec des résultats professionnels. Il est recommandé d'en faire l'entretien quelques fois par année afin d'en conserver l'aspect et les protéger. Peut aussi être utilisé pour les intérieurs d'automobiles.

Leather furniture kit

Two products to help maintain and protect the beauty of your favourite furniture (chairs) or leather items with professional results. It is recommended that you condition your leathers a few times a year in order to conserve and protect them. Product may be used for car interiors.

Nettoyeur doux pour cuir

Gentle Leather cleaner
(HNET-8)

8 oz. (250 ml)



Nettoyeur pour le cuir, excepté le suède et le nubuck. Vaporiser et essuyer avec un chiffon propre. Appliquer ensuite le protecteur Artistic pour le cuir.

Cleaner for leather, except suede and nubuck. Spray on and wipe off with a clean cloth. Follow-up with an application of Artistic leather protector.

Artistic
PROFESSIONNEL



Fait au Québec, Canada / Made in Quebec, Canada

Protecteur pour le cuir.
Leather protector (H-TEC)
8 oz (250 ml)



Protecteur spécialement formulé pour tous les genres de cuirs, excepté le suède et le nubuck. Utilisé fréquemment, conserve l'apparence et prolonge la beauté de vos articles de cuir (vêtements, sacs à main, chaussures). Il est recommandé d'utiliser le nettoyeur *Artistic Professionnel* au préalable.

Specially formulated protector for all types of leathers, except suede and nubuck. Used often, helps maintain the appearance and prolong the beauty of your leather items (clothing, handbags, shoes). It is recommended that you use Artistic Professionnel cleaner beforehand.

Protecteur hydrofuge
Waterproof protector
PROHYDRO
8 oz (250 ml)



Notre protecteur en atomiseur crée une barrière invisible qui empêche l'eau et les taches de s'installer. Formule à base d'eau et de silicone. Convient à tous les types de cuirs, de suèdes et nubuck.

Specially formulated waterproof protector for the care of all type of leather, suede or nubuck. Waterbase and silicone formula. Invisible barrier that prevents water and stains from settling.

Décapant/Deglazer
Stripper/Deglazer (H-DEC)
8 oz (250 ml) et/and 32 oz (750 ml)



Étape préalable à la teinture.
Pre-dyeing step.

Soulier / Shoe
Extenseur à cuir
Leather stretcher
(HSS-120ml)
4 oz. (120 ml)



Gallon sur commande
Gallon on request

Adoucit et agrandit de façon permanente les chaussures, bottes, gants de cuir, suède ou nubuck.

Permanently stretches and softens shoes, boots, and gloves made of leather, suede or nubuck.

Pâte de remplissage
Filling paste
(H355)
100 gr



Pour réparer trous, craquellement ou l'usure sur le cuir. Souple et élastique. Appliquer avec spatule métallique ([3439-00](#)) en fine couche.

To repair holes, cracks or wear on the leather. Soft and flexible. To be applied in thin layers with metal spatula ([3439-00](#)).

Savon à selles Saddle soap
Saddle soap (HSAD)
4 oz (120 ml)



Nettoie et assouplit le cuir. *Cleans and restore.*

Graisse
Dubbin Oil (HDUB)
4 oz. (120 ml)



Fait pour nos hivers

Revitalisant traditionnel à base d'huile animale de qualité, adoucit et imperméabilise vos bottes et souliers de cuir véritable et imitation. Un emploi régulier aidera à conserver vos bottes et chaussures à l'épreuve du calcium et de l'eau.

Made for our Winters

Animal oil-based traditional quality conditioner softens and waterproofs your leather and imitation leather boots and shoes. Regular use will help conserve and protect your boots and shoes against calcium and water.

Huile de pied de boeuf 100% pure
100% pure Neatsfoot oil
21997-08 8 oz (250 ml)
21998 32 oz (1L)
21999 1 gallon (4 L)



Idéal pour remplacer les huiles évaporées du cuir par des huiles animales de qualité. Protège et assouplit vos articles de cuir soumis à une utilisation robuste et une exposition au plein air (selles, bottes, etc.).

Ideal for replacing evaporated leather oils with quality animal oils. Protects and softens leather articles subjected to rugged use and the great outdoors. (saddles, boots, etc.).

TEINTURE, ADHÉSIFS ET ENTRETIEN DU CUIR / LEATHER DYEING, ADHESIVES AND CARE

TEINTURE POUR LE CUIR FIEBING'S / FIEBING'S LEATHER DYES



Fiebing Leather Dye

Fabriqué aux États-Unis; teintures à base d'alcool. Sèche rapidement et uniformément. Un mélange entre elles est possible pour créer votre couleur. Chaque bouteille de 4oz comprend aussi le tampon de mouton. / Made in USA. Alcohol-based dyes. Dries and mixes easily to create your colour. Each 4oz bottle includes one wool dauber.

Toutes les couleurs sont disponibles dans le 4oz (120ml) ou 32 oz (1 litre). Exceptées les couleurs blanc, beige, orange et rouge foncé qui sont sur commande. / All colors are available in 4oz (120ml) or 32 oz (1 litre). Except the white, beige, orange and dark red colors that are on order.

Couleurs disponibles dans le 4 L. / Available colors in 4 L. :

- 01 noir/black
- 02 chocolat/chocolate
- 04 brun moyen/medium brown
- 07 cordovan
- 29 tan léger/light tan

- 2100 + COULEUR 4 OZ
- 2101 + COULEUR 32 OZ
- 2102 + COULEUR GALLON



2100-COUL

Fiebing Pro Dye

Teinture à l'huile professionnelle Fiebing. Disponible en plusieurs couleurs. / Professional Fiebing oil dye. Available in many colors

- 2110 + coul. 4 oz.
- 2111 + coul. 32 oz.(pinte)
- 2112 + coul gallon (noir seulement/ black only)



Disponibles sur commande : vert, bourgogne, bleu royal, rouge, jaune et chocolat / Available on request : green, mahogany, bleu, red, yellow and chocolat.

TEINTURE, ADHÉSIFS ET ENTRETIEN DU CUIR / LEATHER DYEING, ADHESIVES AND CARE

PEINTURE ACRYLIQUE À L'EAU FIEBING'S POUR LE CUIR / FIEBING'S ACRYLIC LEATHER PAINT (CODE 90010)



La peinture pour cuir Fiebing's acrylique offre une longue durée, à séchage rapide, destinée à recouvrir de couleur les surfaces en cuir lisse. Flexible et résistant à l'eau. Donne aussi une excellente finition sur les bordures.

Quick drying, long lasting, use Fiebing's acrylic leather paint for color coating smooth leather surfaces. Flexible and water resistant. Makes for a great edge finish too.

Bouteilles de 2 oz liquide (59ml)

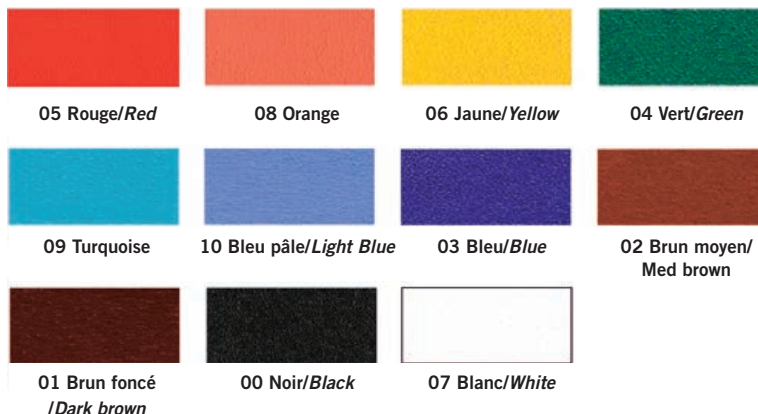

AUTRES PRODUITS POUR LA TEINTURE / OTHER PRODUCTS FOR DYEING



Teinture à bordure Fiebing's Edge kote

Flexible, résistant à l'eau, semi-brillant.
Flexible, water resistant, semi-gloss.
4oz (120 ml) ou/or 32 oz (1 litre).

- 2225-01** noir/black 4 oz
- 2225-03** noir/black 32 oz
- 2226-01** brun/brown 4 oz
- 2226-03** brun/brown 32 oz



Aérosol Fiebing's «Saddle lac». Fiebing's "Saddle lac" spray.

Laque transparente à séchage rapide protégeant la sellerie contre les saletés et le dessèchement dû à une exposition aux éléments. Fini brillant, lisse et dur, tout en étant flexible.
Quick drying lacquer finish that protects saddlery against the drying out and soiling effects of exposure to the elements. Glossy, smooth, hard and flexible.

- 1988-00** 13 oz (383.5 ml)



Resolene, couche de finition. Top coating

4 oz (120 ml) ou/or 32 oz (1 litre)

- 2270-01** 4 oz
- 2270-03** 32 oz

Une finition en acrylique flexible, durable et résistante à l'eau pour les cuirs teints, vieillis (antiques) ou polis.
A flexible, durable, water resistant acrylic top finish for dyed, antiqued or polished leather.



Tampon avec bout en mouton pour teinture Wool dauber

Idéal pour teindre les bordures./
Ideal for edge dye.

- 3443-00** 1/2" Petit/Small sac /bag 10
- 3443-99** 1/2" Petit/Small sac de/ bag 100
- 3445-00** 3/4" Moyen/Medium sac/bag 10
- 3445-99** 3/4" Moyen/Medium sac/bag 100
- 43081-00** 1" Jumbo sac/bag 10
- 43081-002** 1" Jumbo sac/bag 100



Tan Kote Couche de finition. / Top coat

Pour un fini très résistant et durable, anti-moisissure pour tout genre de cuirs lisses et souples.
For a protective moisture-resistant finish on all smooth leathers.
4 oz (110 ml) ou/or 32 oz (1 Litre)

- 2220-01** 4 oz
- 2220-03** 32 oz



RETM Retailles de mouton. Sheepskin remnants.

Idéal pour teindre vos projets de cuir.
Ideal for dyeing your leather projects.

- 5\$ le sac/bag**

AUTRES PRODUITS / OTHER PRODUCTS



HREP Repel

Protecteur imperméable. Protège contre la pluie et les taches. Pour tous les types de cuirs, suèdes et tissus.
Repel rain & stain repellent, For leather and suede products and fabrics.

150 g



HDEG4 Décapant Deglazer

Utilisation professionnelle pour préparer le cuir à recevoir une teinture et refinir. N'affecte pas la flexibilité du cuir.

Used by professionals to prepare leather for dyeing and refinishing. Will not impair softness and flexibility.

4 litres



HFG FabriGard aérosol FabriGard aerosol

Imperméabilisant pour tissus et cuir. Aussi efficace contre les matières grasses. Idéal pour l'intérieur d'auto et la maison.

Water, stain and spill repellent for fabric and upholster. Also effective against greasy substances.

300g



HSS4 Extendeur à chaussure par Sluyter Shoe stretch extensor by Sluyter

Utilisation par des professionnels. À base d'alcool. Bon pour tous les types de cuir ou suèdes. Étire le cuir quand vous marchez.

Used by professionals. Alcohol based product. Good for all type of leather or suede. Stretches your shoes while you walk.

4 litres



HMASTER Master Quick Shine

Produit de finition à vaporiser sur du cuir qui donne une aspect brillant. Ne tâche pas les mains, ni les vêtements. Contient de la lanoline. Imperméable.

Finishing spray for leather with a sparkling shine effect. Will not stain hands or clothing. With lanolin.

13 oz.



HUILE

Pour machine à coudre.
Sewing oil.

1 litre.



HSUPER Super slip Silicone

Lubrifiant et antiadhésif de silicone à usages multiples. *Super slip silicone in spray, many applications.*

14 oz.

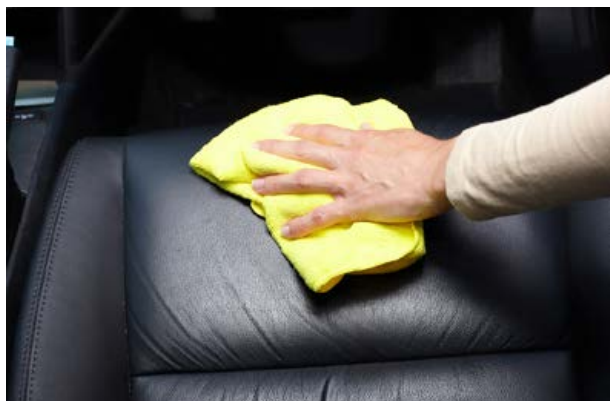

Mr. Sole-utions Dr. Alphonso



Fait au Québec, Canada / Made in Quebec, Canada



1 litre (32 oz)

4 litres (1 gallon)

HDA7300
1 litre (32 oz)

HDA3870

Colle caoutchouc/ Rubber cement

32oz - 1L / Gallon - 4 L

Le 3870 est une colle caoutchouc à base de solvant utile pour le montage d'articles et de vêtements de cuir.

The 3870 is a fast drying solvent-based temporary combining rubber cement used in the leather garment industry.

HDA1220

Colle contact (clair) / Contact cement (clear)

32oz - 1L / Gallon - 4 L

Le 1220 est une colle contact à base de solvant utilisée pour assembler des matériaux plus difficiles à coller comme les matières plastiques, le thermoplastique et le polyéthylène, en plus des matières normalement collées avec une colle contact. Colle transparente en séchant.

The 1220 is a solvent based contact cement used for bonding a wide variety of difficult to bond substrates, such as plastics, thermoplastics and polyethylene as well as the normal to bond materials. Transparent glue when dry.

HDA7254

HDA7256

Colle contact / Contact cement

32oz - 1L / Gallon - 4 L

Colle contact à base de solvant de haute qualité utile pour une multitude d'usage. Elle est recommandée pour coller le cuir, le tissu, les fibres de carton, le caoutchouc synthétique, le crêpe et le EVA. (7254 est plus épaisse que 7256)

High quality solvent-based contact cement used for bonding a wide variety of leather, fabric, synthetic rubber, crepe and EVA materials. (7254 is thicker than the 7256)

HDA3912

Solvant-nettoyant / Solvent cleaner

32oz - 1L en inventaire/ in stock
Gallon - 4L sur demande /on request

Le 3912 est un solvant utilisé pour nettoyer ou diluer la colle contact Dr. Alphonso 7254.

The 3912 is a solvent used as a cleaner or a diluent for contact cement Dr. Alphonso 7254.

HDA4625

HDA4624

Colle contact uréthane / Urethane cement

32oz - 1L / Gallon - 4 L

Adhésif d'uréthane spécialement formulé pour unir les empeignes de cuir, de vinyle et de fibres synthétiques à des semelles de polyuréthane, de thermoplastique (TPR), de caoutchouc, de crêpe et de PVC.

(4625 est plus épaisse que 4624)

Urethane based adhesive for sole attaching with a low heat activation temperature and heavy duty spotting tack. The 4625 has been formulated for bonding leather, vinyl and fabric uppers to polyurethane, thermoplastic, rubber, crepe and PVC soles. (4625 is thicker than the 4624)

HDA3920

Solvant-nettoyant pour 4625 / Solvent-Cleaner for 4625

32oz - 1L / Gallon - 4 L

Le 3920 est un solvant utilisé pour nettoyer ou diluer la colle contact uréthane Dr. Alphonso 4625.

The 3920 is a solvent used as a cleaner or a diluent for urethane cement Dr. Alphonso 4625.

HDA2525

Apprêt uréthane pour 4625 Urethane primer for 4625

32oz - 1L / Gallon - 4 L

Le 2525 est un apprêt à base d'uréthane qui améliore l'adhésion des semelles de polyuréthane, de thermoplastique (TPR) et de caoutchouc avant d'être cimenté avec le Dr. Alphonso 4625.

The 2525 is a urethane-based primer used to improve adhesion to polyurethane, thermoplastic (TPR) and rubber soles used as a first coat before cementing with Dr. Alphonso 4625.

HDA3217

Apprêt Eva pour 4625 / Eva primer for 4625

32oz - 1L / Gallon - 4 L

Le 3217 est un apprêt à base de solvant utilisé spécifiquement comme première couche sur les matériaux d'EVA avant d'être cimenté avec le Dr. Alphonso 4625.

The 3217 is a solvent based colorless primer for EVA used as a first coat before cementing with Dr. Alphonso 4625.

HDA7300

Colle au latex / Latex glue

32 oz - 1 L. en inventaire/ in stock
Gallon - 4 L. sur demande /on request

Le 7300 est une colle à base de latex convenable pour une variété d'opérations d'assemblages utilisant le cuir et la fibre tel que pour les bouts durs des chaussures. Elle peut servir pour les doublures et pièces de cuir avant la couture. Elle offre une attache rapide et est idéale pour les matières poreuses et le cuir à l'huile.

The 7300 is a solid latex recommended for a variety of combining operations, as well as some assembly operations involving box toes. The fast initial grab offered by this adhesive makes it ideal for use with difficult to adhere substrates such as high oil content leathers and porous materials.

HDA3815

Acide de préparation Satreat Satreat

Gallon - 4 L. sur commande /on request

Le Dr. Alphonso 3815 est une solution halogénée à base de solvant utilisée pour traiter les surfaces de caoutchouc, de thermoplastique et de kraton et les rendre prêtes à être cimentées avec le Dr. Alphonso 4625. Le 3815 améliore l'adhésion et empêche l'huile de ressortir du matériel.

Dr. Alphonso 3815 is a solvent based halogenating solution used to treat the surface of Kraton, thermoplastic (TPR), and composition rubber soles materials to enable them to be bonded with Dr. Alphonso 4625 urethane cement. The 3815 improves adhesion and prevents the oil from coming out of the material.

TEINTURE, ADHÉSIFS ET ENTRETIEN DU CUIR / LEATHER DYEING, ADHESIVES AND CARE

ACCESSOIRES POUR APPLICATION / APPLICATION ACCESSORIES



HDAPP
Pinceau avec couvert de métal
Brush with metal cap



HDAP-GLUE
Pinceau colle #8
#8 Glue brush
3/8" (9 mm)



HDAP8
Pinceau colle no. 8
#8 Glue brush
5/8" (15 mm)

HDAP10
Pinceau colle no. 10
#10 Glue brush
3/4" (19 mm)



HDAPS
Pinceau Satreat avec
manche en plastique
Satreat brush with plastic handle.
7/8" (22 mm)



Ces contenants vous feront économiser colle et pinceaux! Comprend pinceau et capuchon hermétique. Pour réduire les évaporations et éviter ainsi l'épaississement.
These glue containers will save your glue and brushes! Includes glue brush and hermetic cap. To minimize evaporation and avoid thickening.

HMINOR : Petit /Small : 400ml
HMED : Moyen/Medium : 900ml



HB120
Bouteille vide avec pinceau.
Empty bottle with brush
120ml

AUTRE ADHÉSIFS / OTHER ADHESIVES



HSU-120
Stick-um / Sluyter

Adhésif en petit format de 120 ml très performant à base de solvant à haute résistance. Formule à base de caoutchouc néoprène appliqué au pinceau contenu dans la bouteille. Nombreuses applications pour le collage de divers matériaux, notamment le plastique, le bois, le métal, le cuir, le caoutchouc, le papier et les tissus. Pour coller le cuir aisément pour ensuite le coudre.

A high strength solvent based contact adhesive. Neoprene rubber based formula applied by brush included in the bottle. Numerous applications for bonding a variety of materials including plastic, wood, metal, leather, rubber, paper and cloth.



Ruban adhésif transparent à coller, double face.
Double-side transparent tape.

100 M

GT6 6 mm (1/4")
GT12 12 mm (1/2")
GT18 18 mm (3/4")

TEINTURE, ADHÉSIFS ET ENTRETIEN DU CUIR / LEATHER DYEING, ADHESIVES AND CARE

COLLE / GLUE



HCYANO2

Colle cyano / *Cyanoacrylate glue*

Mince, médium ou épaisse.

Thin, medium or thick.

2 oz.

Grade 5

Sèche entre 1 à 3 secondes

Surfaces lisses non poreuses

Dry between 1 to 3 seconds

Non porous smooth surfaces

Grade 100

Sèche entre 5 à 15 secondes

Idéal pour surfaces semi lisses, légèrement rugueuses et/ou poreuses

Dry between 5 to 15 seconds

Use on semi-smooth, rough or porous surfaces

Grade 700

Sèche entre 30 à 45 secondes

Plus de temps pour ajuster

S'applique bien à tous les types de surfaces et/ou surfaces inclinées

Dry 30 to 45 seconds

More time to make adjustments

Convenient to all types of surfaces or inclinations.



HDES2

Dessoudeur de colle cyano.

Debonder : dissolves all cured cyanoacrylate adhesives.

2 oz.



Accélérateur pour colle cyano.

Cyanoacrylate accelerator glue.

HACC2

2 oz. avec pompe/*with pump*



HCYANO-noire

Colle cyano noire flexible caoutchouc.

Grade 700.

Flexible black cyanoacrylate glue.

700 Grade, rubber toughened.

2 oz.





OUTILS POUR ATELIER DE PRODUCTION / TOOLS FOR PRODUCTION WORKSHOP



N-4

Machine manuelle professionnelle multi-usage. Se fixe à une table de travail pour poser rivets, oeillets, boutons pression, perforateurs et enclumes. Matrices non incluses et vendues séparément. Nous contacter pour plus d'informations.

Professional manual multi-use machine. Fix-it to table for dies, rivets, eyelets, snaps, perforators and anvils. Dies not included and sold separately. Contact us for more information.



MR-10S

Matrice à oeillet «sheet» pour machine N-4.
«Sheet» eyelet matrix for N-4 machine.
#00,0, 01, 02, 03, 04.



MR-2

Matrices pour pose de rivets pour machine N-4.
Rivet die for N-4 machine.
#32, 33, 34, 36.



MR-1

Perforateur pour machine N4.
Punch for N-4 machine.

Grandeurs disponibles/ Available sizes :
(Mesures en millimètre / Measurements in millimetre)
1,5, 2, 3, 3,5, 4, 4,5, 5, 5,5, 6, 6,5, 7, 8,
10, 11, 12, 13, 14, 16, 18 mm



MR-2-2T

Matrice pour pose de rivets double têtes pour machine N-4.
Double cap rivet die for N-4 machine.
#32, 33, 34, 36.



MR-3

Enclume acier ou laiton pour machine N-4.
Steel or brass anvil die for N-4 machine.



MR-4

Matrice pour bouton-pressions pour machine N-4. / Snap setters for N-4 machine.
Série 80 Series et /and Série 95 Series



Manche/Handle

Perforateur/Perforator
Non inclus/Not included

MR-18

Manche universel pour perforateur MR1.
Même perforateur qu'utilisé sur la machine N4. Perforateur non inclus.
Universal handle for tube MR1. Same perforator as the one used on N4 machine.
Perforator sold separately.



MR-15

Matrice pour N-4 pour pose de bouton pression français (4 parties) Série SNF844/
Snap setter for N-4 for French snap (4 parts)
SNF844 serie



MR-11

Matrice pour pose d'oeillets pour machine N-4. / Eyelet die for N-4 machine.
#50, 51, 52, 54.



N-5

Machine manuelle professionnelle multi usage. Se fixe sur une table de travail. Matrices sur commande nous contacter pour informations supplémentaires.

Professional multi-purpose manual machine. To be fix on a work table. Dies on request. Contact us for additional information.

OUTILS POUR POSE AU MARTEAU / TOOLS TO INSTALL WITH MALLET



MR-4029
Pince «Press-N-Snap» pour boutons-pression série 95. Inclut 4 matrices. / *Press-N-Snap plier hand tool for 95 series snap, including the 4 dies.*

MR-4028
Rondelle de caoutchouc pour pince MR-4029.
Rubber ring for portable hand tool plier MR-4029.



MJ-60125
Metal Complex
Ensemble poseur de bouton pression.
Snap rivet setter set.



MR-22920
Matoir bouton pression Osborne #229 série 80
Snap Setter Osborne #229 for snap #80



MR-22924
Matoir bouton pression Osborne #229 série 95
Snap Setter Osborne #229 for snap #95



MR-23024
Matoir à boutons pression série 95
Snap Setter Osborne #230 for snap #95

MR-23020
Matoir à boutons pression série 80
Snap Setter Osborne #230 for snap #80



MR-2424
Matoir pour pose manuelle de boutons-pression série 95 Osborne.
Manual Snap setter for serie 95 Osborne.



MR-453
Enclume pour pose de bouton-pression, et rivet, 1 côté plat et l'autre concave.
Anvil for snap and rivets, 1 flat side and 1 concave side.



MR-17
Matoir à boutons pression français Série SNF844 à poser au manteau (4 parties).
4 parts setter for French snaps. SNF844 serie.



MJ-60203
Metal Complex
Enclume de métal miniature
Miniature steel anvil.
4 1/4" X 1 1/2" X 1" - 0.85lb



MJ-60202
Enclume de metal « Metal Complex »
2-1/2" x 2-1/2" x 3/4".
Bench metal block 2-1/2" x 2-1/2" x 3/4" «Metal complex».



OUTILS / TOOLS

OUTILS POUR POSE AU MARTEAU / TOOLS TO INSTALL WITH Mallet POUR RIVETS / FOR RIVET



MJ-60123
Ensemble poseur de rivets
4 grosseurs (2pcs).
Rivet setter set - 4 sizes (2 pcs).



MR-8100
Matoir exclusif pour rivet
Hand tool rivet setter
#33, #34, et/and #36



8100-01
Matoir pour rivet # 32
#32 hand tool rivet setter



MR-170-9
Matoir pour rivets en cuivre. Osborne #9
Rivet setter for copper rivets. Osborne #9



Matoir pour Piolino. / *Piolino hole punch.*
3779-03 4 mm
3779-04 5 mm
3779-05 6 mm
3779-06 7 mm
3779-07 8 mm

Note : Choisir la grosseur du matoir en fonction de la partie la plus fine du Piolino et tenir compte de l'épaisseur du cuir. Il serait possible que par exemple vous deviez choisir le 4mm pour un Piolino qui a une tête de 7mm, etc.

Note : Choose the size of the perforator according to the thinner part of the Piolino and the thickness of the leather. For example, you may chose the 4mm perforator for a 7mm-headed Piolino.



MR-105-1
Poinçon passe poil /
Round pipping punch

POUR OEILLETS / FOR GROMMETS



MR-8094 52/54
Matoir oeillets avec enclume
Grommet hand tool setter with anvil
Grandeurs/Sizes :
052 ou/or 054 (5/32 ou/or 11/64)



MR-8093-51
Matoir à oeillet avec enclume
Grommet hand tool setter with anvil
Grandeurs/Sizes : #51(3/16«)



MR-8095-50
Matoir à oeillets #50 - 1/4" (2 parties) /
#50 hand tool for eyelets (2 part)



MR-167-316
Matoir à oeillets 3/16" Osborne/
3/16" Eyelet setter Osborne
Grandeurs/Sizes : 051 ou/or 052



MR-9
Matoir pour oeillets / *Osborne Grommet setter*
Grandeurs/Sizes : 050, 051, 052, 054

MR-9E
Enclume à oeillet 051 ou 050
Anvil for eyelet setter #51 or 50



MR-235 + # DE GRANDEUR
Matoir Osborne pour oeillets "sheet" pour
apprenti. / *Osborne Grommet setter die with
maul for apprentice.*
Grandeurs/Sizes : 00 (3/16"), 0 (1/4"),
1 (9/32"), 2 (3/8"), 3 (7/16"), 4 (1/2")



MR-216 + # GRANDEUR/SIZE
Matoir au marteau Osborne pour oeillets
professionnels. / *Osborne Professional Sheet
grommet maul inserting die.*
Grandeurs/Sizes : 00 (3/16"), 0 (1/4"),
1 (9/32"), 2 (3/8"), 3 (7/16"), 4 (1/2"), 5 (5/8")
Sur commande/On command : 6 (13/16")
Voir /See MR-500 pour perforateur/for punch (p. 62)



MR-217 + # DE GRANDEUR/SIZE
Matoir Osborne pour oeillets à griffe "spur" /
Osborne Grommet maul inserting die spur.
Grandeurs/Sizes : 0 (1/4"), 1 (9/32"), 2 (3/8"),
3 (7/16"), 4 (1/2"), 5 (5/8")
Voir /See MR-500 pour perforateur/for punch (p. 62)



PERFORATEURS / HOLE PUNCHES

Meilleur vendeur
«**DÉBUTANT**»
Best Seller
"BEGINNER"



MR-223

Poinçon Osborne rotatif de qualité.
Osborne Quality Revolving Punch

Tube de remplacement / *Replacement tube* :

MR-223T-0	#0 / 5/64"
MR-223T-1	#1 / 3/32"
MR-223T-2	#2 / 16/64"
MR-223T-3	#3 / 1/8"
MR-223T-4	#4 / 5/32"
MR-223T-6	#6 / 3/16"



MR-3229-00

Poinçon à tige pointue pour couture à la main comportant une plateforme rotative de 5 différentes tailles de trous. Idéal pour percer des cuirs minces (entre 0.5 et 4oz).

Hand-stitching drive punch featuring a rotating platform of 5 different hole sizes. Ideal for piercing thin leathers (between 0.5 and 4oz).

Remplacement/Replacement :

Tige perceuse/drill rod : MR-3229-T

Ressort de poignée/Handle spring: MR-3229-R

Meilleur vendeur
«**PROFESSIONNEL**»
Best Seller
"PROFESSIONAL"



3930-00

Poinçon rotatif #155 Osborne avec perforateurs 0 à 7. / *Osborne #155 rotary punch 0 to 7.*

3930-16

Poinçon rotatif #155 Osborne avec perforateurs 1 à 6. / *Osborne #155 rotary punch 1 to 6.*

MR-155A Enclume de rechange / *Spare Anvil*

MR-155-SP Ressort de rechange / *Spare Spring*

MR-155T + # grandeur

Tubes de remplacement individuels pour poinçon 3930-00 / *Revolving Punch Replacement Tubes for 3930-00*
00, 0, 1, 2, 3, 4, 5, 6 et 7

MR-155T-07

Pour poinçon 3930-00.
Ensemble complet de tubes de remplacement pour de #0 à #7. / *Revolving Punch Replacement Tubes 0 to 7*

MR-155T-16

Pour poinçon 3930-16.
Ensemble complet de tubes de remplacement pour de #1 à #6. / *Revolving Punch Replacement Tubes 1 to 6*



MR-153 + # grandeur

Poinçon à ressort à trou unique Osborne pour tubes de grandeurs # 000, 0, 1,2,3,4,5,6,7, 8,9 ou 10. Les tubes de 000 à 7 inclus sont interchangeables avec une même poignée (commander les tubes séparément). Le #8 se vend avec sa poignée. Les #9 et #10 peuvent s'interchanger.

MR-153T : grandeurs des tubes supplémentaires #000, 00, 1,2,3,4,5,6,7, 8,9 ou 10

MR-153A : enclume de remplacement

Osborne single-hole spring punch for tubes of sizes # 000, 00, 1,2,3,4,5,6,7, 8,9 or 10. The tubes from 000 to 7 inclusive are interchangeable with the same handle (order the tubes separately). The # 8 is selling with its handle. # 9 and # 10 can interchange.

MR-153T: additional tubes sizes # 000, 00, 1,2,3,4,5,6,7, 8,9 or 10

MR-153A: replacement anvil



3231

Emporte-pièce universel / *Universal punch tube.*

Grandeurs / *Sizes* : #00. 0, 1, 2, 3, 4, 6



MR-220-00

Poinçon économique Osborne #220 à trou unique #00 pour couture à la main (grandeur la plus demandée). Autres grandeurs de tubes disponibles sur demande (de 00 à 7, soit 9 possibilités). / *Economical Spring Punch Osborne #220 with unique hole #00 for hand sewing (the most requested size tube). Extra tube sizes available on request (from 00 to 7, therefore 9 possibilities).*



PERFORATEURS / HOLE PUNCHES



3003-00

Mini perforateur avec douille de rechange et clefs. / *Mini punch set.*

Grandeur / *Sizes:* 2 mm, 2,5 mm, 2,8 mm, 3,2 mm, 4 mm, et 4,8 mm



MR-K156

Perforateurs Osborne K156 dans une boîte. *Snap set Osborne #K156 in a box.*

Douilles / *Socket*

1/4", 5/16", 3/8", 7/16", 1/2", 5/8", 3/4", 7/8", 1".



MR-K157

Mini poinçon pour K157 Osborne.

Mini punch set k157 Osborne.

Grandeur / *Sizes:* #0 à #6
5/64", 3/32", 7/64", 1/8", 5/32", 11/64", 3/16"



MR-K245

Ensemble perforateur Osborne à ceinture 6 pièces / *Belt Punch Set Osborne (6 parts)*

Grandeur / *Sizes:* 1/8", 5/32", 3/16", 1/4", 5/16", 3/8"



MR-245 + # grandeur

Perforateur à ceinture long et fort à la main, avec dévidoir pour professionnels Osborne. / *Belt round punch Osborne*
Disponible dans les grandeurs / *Available sizes:*

#00	1/16"	#9	1/4"
#0	5/64"	#10	17/16"
#1	3/32"	#11	9/32"
#2	1/8"	#12	5/16"
#3	9/64"	#13	11/32"
#4	5/32"	#14	3/8"
#5	11/64"	#16	7/16"
#6	3/16"	#1/2	1/2"
#7	13/64"	#9/16	9/16"
#8	7/32"		



MR-149

Perforateur "Arch punch" par Osborne, forgé dans l'acier au carbone, disponible dans plusieurs grandeurs de ronds de 1/8" à 2-1/8". Nous avons en main les plus populaires, dont 1/2", 3/4", 1", 1-1/8", 1-1/4", 1-1/2", 1-3/4"; pour les autres grosseurs, sur commande. L'ensemble # MR-K14 représente les choix les plus populaires.

«Arch punch» by Osborne, forged in carbon steel, available in several sizes from 1/8 to 2-1/8" rounds.

We carry individually the most popular ones, including 1/2", 3/4" -1", 1-1/8", 1-1/4", 1-1/2", 1-3/4", 1-1/2", 1-3/4"; the other ones are on request. For a kit, see the MR-K14.



MR-K14

Ensemble de perforateurs Osborne 7 pièces (comprend un étui) / *Osborne Arch punch set 7 pieces (comes with case)*



MR-500 + # grandeur

Perforateur Osborne no.500 qui correspond aux grandeurs des œilletons anti-rouille (sheet). / *Osborne punch no.500 used with corresponding sizes of grommets and setting dies of Sheet*

Grandeur / *Sizes :*

#1	9/32"	#4	1/2"
#2	3/8"	#5	5/8"
#3	7/162"		



Taille bout de courroie Osborne. / *Osborne Strap End Punch (English Point).*

MR-150

Bout rond / *Round end*
3/8", 1/2", 5/8", 3/4", 1", 1-1/8", 1 1/4", 1 1/2", 1 3/4", 2".

MR-0150

Bout en « V » / *V end*
Pointe anglaise / *English point*
3/8", 1/2", 5/8", 3/4", 7/8", 1", 1 1/8", 1 1/4", 1 1/2", 1 3/4", 2".



MR-151

Perforateur à ceinture oblong Osborne. / *Oblong Osborne belt punch.*

Disponible dans le / *Available in :* 3/8", 1/2", 5/8", 3/4", 7/8", 1", 1 3/8", 1 1/4", 1 1/2", 2".

PERFORATEURS / HOLE PUNCHES



MJ-60004
Ensemble 3 marqueurs trous pour cuir
(4 pièces). /
Leather embossing/spacing set
(4 pieces).



8091-00
Ensemble de roulettes marqueurs de
points 4 roulettes + tournevis inclus./
Craftool spacer set with 4 removable
spacing – overstick wheels.



MJ-60030
Fourchette de perforation 1 tige droite
3.1mm.
Lacing chisel 1-perforation prong
straight. 3.1mm



MJ-60031
Fourchettes de perforation 4 tiges droite
3.1mm. / *Lacing chisel*
4-perforation prong straight 3.1mm.



MJ-60032
Fourchette de perforation 8 tiges droites
3.1mm./
Lacing chisel perforation 8-prong straight
3.1mm.



MJ-60033
Fourchette de perforation 4 tiges angle
3.1mm./
Lacing chisel perforation 4-prong
angled 3.1mm.



3201-03
Perforateur 3 trous ronds couture à la
main / *3 round hole punch for hand*
stitching
1,5 mm X 3 mm

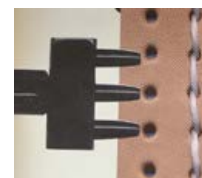

3008-00
Jeu de fourchettes de perforation.
6 dans 1. / *Thonging chisel set. 6 in 1*



3009-00
Jeu de poinçons, pointe diamant
(biseau)./
Diamond hole chisel set

COUTURE / STITCHING



1216-120

Alène pour couture à la main *Speedy stitcher*. Incluant une bobine de fil ciré naturel, ainsi que 2 aiguilles (droite et courbée). / *Speedy stitcher hand sewing. Including a natural waxed coil wire, and 2 needles (straight and curved).*

Fil voir [page 8](#) / *For lace see page 8*, #1198, 1199, 11207.



Aiguilles de remplacement voir / *Replacement needles*

1216-130 petite/*small*
1216-130A grosse/*large*
1216-130B courbée / *curved*



MR-421

Aiguille à lacer avec manche Osborne. Idéal pour petits travaux. Aiguille 2 1/2" / *Osborne Lacing awl. Ideal for small objects. 2 1/2" long.*



MR-928

Alène à coudre le plus populaire d'Osborne avec vis de resserrement pour faciliter la solidité de l'aiguille. Aiguilles vendues séparément (Voir ci-dessous).

Sewing Osborne awl most popular. Knurled chuck makes it easy to tighten. Needles sold separately. (See below).



MR-145

Alène Osborne à coudre avec mandarin et clef. Extrémité moulée permettant une prise facile et empêche de glisser. Aiguilles vendues séparément. Voir ci-dessous.

Sewing Osborne awl. Knobbed end permits easy grasp and prevents slipping. Comes with chuck and wrench. Awes sold separately. See below.

Aiguilles pour MR-928 ou MR-145 / *Needles to fits in MR-928 or MR-145*

MR-42

Aiguilles alène Osborne 1-1/2" pointe diamant. / *1-1/2" Osborne needle for stitcher diamond point.*

MR-54

Aiguilles pour alène Osborne 2" / *2" Awl needles Osborne.*



MR-Alene #8

Alène perçante en fer forgé. Pour gros lacet avec manche en bois. L'alène visible 6 1/4" est très robuste puisqu'elle va jusqu'au bout du manche (sa longueur totale est 10 1/4") / *Forged collar awl with hardwood handle. Riveted tang goes completely through the handle for added strength. Sharp cuttle edges to punch its own slit for heavy laces.*

MR-Alene #8B

Alène à bout émoussé en fer forgé, 6" visible. Pré-perforer le cuir au préalable. Manche de bois. / *Forged collar awl with blunted and polished edges to be used in pre-punched leather.*



MJ-60013

Ensemble de poinçon interchangeable. 4 en 1. / *Interchangeable awl set. 4 in 1.*



MR-478

Alène perforateur sans fil #478. / *Scratch awl #478.*
 Trou fin. / *Small hole.*



MR-477

Outil Osborne pour agrandir trou dans cuir. / *Osborne fid awl for enlarging holes in leather.*
 Trou large. / *Large hole.*



MJ-60131

Grippe en bois pour coudre et lacer le cuir. / *Stitching & lacing Pony.*

* cuir et lacet non inclus. / *Leather and lace not included.*

COUTEAUX / KNIFES



MJ-60017
Couteau rotatif ajustable. /
Swivel knife - adjustable.



MR-444
Couteau rotatif Osborne à ciseler le cuir. /
Osborne Swivel cutter.



MJ-60103
Couteau de précision 5 lames
assorties. / Precision knife 5 different blades.



MJ-60100
Couteau de précision avec manchon et
5 lames assorties. /
Precision knife - cushion grip -
5 different blades.



MJ-60025
Couteau rotatif à lame ronde MC. / Rotary
cutter round blade MC

3043-00
Lame de rechange du couteau rotatif. /
Easy grip rotary cutter blade.

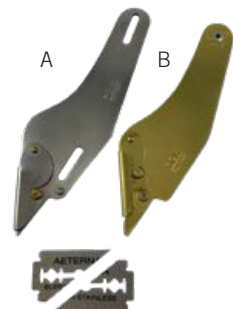

Pour tous vos travaux demandant précision pour couper cuirs et fourrures, voici un couteau dont vous ne voudrez plus vous passer dans votre atelier. Porte-lame de rasoir en diagonal extrêmement tranchant. Lames vendues séparément. / For all your works requiring precise cutting of leathers and furs, here is an essential knife for your workshop. Extremely sharp diagonal razor blade holder. Blades sold separately.

MR-ROMI-A Argent/Nickel
MR-ROMI-B Laiton/Brass
MR-ROMI-LAMES Lames/Blades (20)



MJ-60005
Couteau amincisseur à cuir. /
Leather skiver.



MR-925
Couteau amincisseur de cuir #925
Osborne. / Osborne Leather skiver #925

MR-925-D
Lames pour couteau #925 Osborne (pqt.
de 20). / Blade for Osborne leather skiver
#945 (pack of 20)

MR-925-100
Lames pour couteau #925 Osborne
(pqt. de 100). / Osborne blades for leather
skiver #925 (pack of 100)



MR-71
Couteau Osborne amincisseur 4" 1/2 -
3 oz. / 4-1/2" Head knife Osborne 3 oz.



MR-70
Couteau à parer 5" (4 oz) Osborne #70,
le plus populaire depuis 1826. /
5" (4 oz) round blade Osborne knife.
The most popular since 1826.



MR-469
Couteau amincisseur de cuir côté **droitier**
ou gaucher. / Skiving knife Osborne - **right**
or left hand.



Couteau amincisseur à cuir Osborne #67. /
#67 Osborne Leather knife skiver.

MR-67-0 2" X 1-1/8"
MR-67-1 4-1/8" X 1-1/2"
MR-67-2 4-1/4" X 1-7/8"

Étui de rangement GRATUIT
FREE storage case

POUR COUPER / FOR CUTTING



MR-K460

Ensemble économique d'Osborne de 4 lames interchangeable avec le manchon, emballé dans un carton à suspendre. / *Osborne Handle & 4 extension blades economical Kit, packed in a hang up display card.*



3784-00

Coupe lacets Circulaire Tandy. / *Tandy Lace maker.*

3002-00

Lames de rechange disponibles en paquet de 10 / *Replacement blades available by pack of 10.*



MR-86

Osborne fabrique cette solide machine fendeuse de cuir la plus professionnelle sur le marché. Peut fendre toutes les épaisseurs de cuir. Pour les vrais professionnels. Poids 6 lb / *Osborne is making this solid splitting machine the most professional marketed. Can split any thickness of leather. For the true professionals. Weight 6 lbs.*



3080-00

Coupe-courroies robuste en bois Tandy / *Tandy Wood strip and strap cutter.*

Incluant une lame. / *One blade included.*

3081-00

Lame en extra paquet de 5 / *Extra Blade pack of 5*

POUR TRACER / FOR TRACING



MJ-60014

Gouge en V réglable. / *Gouge adjustable V.*



MJ-60006

Traçoir réglable à graver sur cuir. / *Adjustable leather groover.*



MR-128

Outil de prédilection pour plier le cuir. Ajustement facile pour l'épaisseur de cuir à enlever. Le #MR-128-90 (en forme V) est utilisé pour plier en 2 différents objets comme les cahiers, menus, coffrets ou autre, là où vous nécessitez un angle droit. / *Ideal tool for gauging folds, easy adjustment to any depth. Use # MR-128-90 (V-shaped) to fold for notebooks, cases, menus or more, or where a sharp right angle is needed.*



8069-00

Outil à rainures Tandy, ajustable, plus robuste que le MJ-60006 / *Tandy Adjustable groover more robust than the MJ-60006.*

MR-128-3: gouge #3, lame de 5/32" blade of 5/32"

MR-128-90: gouge en forme de V / V-shaped



MJ-60007

Traçoir/plieur ajustable pour cuir. / *Leather creaser adjustable.*



MR-106-6

Compas Osborne #106-6 de luxe, ouverture maximum 6". Reste en place. / *The luxe Osborne wing divider #106-6, 6" Maximum opening. Stay on place.*



8072

Traceur réglable. / *Leather groover adjustable.*

POUR BORDURES / EDGE BEAVELER



MJ-60008
Biseauteur de bordure pour le cuir./
Leather edge beveler.



8076
Outil Tandy pour bordure. / *Craftool Edge Bevelers*
Grandeur/Sizes : 2, 3, 4 et/and 5
2 (étroit/narrow) à 5 (large)
Ordre général pour un cuir mince,
prendre les petites grandeurs d'outils
(Exemple : le #0 pour un 2-3 oz)
*Generally, use lower number sizes for
thinner leather and higher # sizes for
thicker leather.*



8077
Biseauteuses de bord oblique. Concave au
verso pour lisser. /
*Craftool beveler with concave back
for burnishing.*
Grandeurs/Sizes: #2,#3 ou/ or #4



MR-125 + # DE GRANDEUR/SIZE
Outil à bordure Osborne #125. /
#125 Osborne common edge tool.
Grandeurs / Sizes: #00 (3/32"), #0 (1/8"),
#1 (9/64"), #2 (5/32"), #3 (3/16"),
#4 (1/16")



MR-126 + # DE GRANDEUR/SIZE
Outil à bordure Osborne #126, fait d'acier
trempé pour une longue durée de vie et
un outil efficace. Forme du biseau en
« V ». Outil idéal pour arrondir les côtés,
même pour un cuir mince./
*#126 Osborne common edge tool, Drop
forged steel of highest quality for long life
and effectiveness. Ideal tool to round
edges, even fine leather.*
Grandeur/Sizes: #0 (1/16"), #1 (3/32"),
#2 (1/8"), #3 (5/32"), #4 (3/16").



MR-127 + # DE GRANDEUR/SIZE
Outil à bordure Osborne #127 /
#127 Osborne common edge tool.
Grandeur / Sizes: #1 (1/32"), #2 (1/16"),
#3 (5/64"), #4 (3/32")



MR-8121-00
Polisseur à bordure en bois. /
Wood edge polisher.



MR-60130
Roulette lisseur de bord en nylon./
Nylon edge slicker.



MR-21
Lissoir Osborne, Cet outil sert à embellir
l'apparence des bords. À utiliser après la
coupe au biseau. / *Osborne Creaser. This
tool will enhance the edges. Round edges
with edge tool before.*
Grandeur disponibles / *Availables sizes :*
#1, 2, 3, 4, 5.



MR-12
Lissoir «creaser» à bordure Osborne/
Osborne Creaser.

Grandeur disponibles / *Availables sizes :*
#1 et/and #2



3439-00
Spatule à bordure en acier inoxydable /
Stainless edge paddle.

CISEAUX ET AUTRE OUTILLAGE / SCISSORS AND OTHERS TOOLS



MJ-60200
Ciseaux à cuir « Metal Complex». /
« Metal Complex » Leather Scissors.



MR-1012
Pince pour fermeture à glissière. /
Zipper stops plier

**MEILLEUR VENDEUR
BEST SELLER**



EZ-CUT
Ciseau à cuir EZ Cut Osborne 8" pour
professionnels. / 8" Osborne leather
scissors for professional.



MR-1014
Gabarit pour fermeture à glissière. /
Zipper jig.



MR-KAI7250
Meilleur ciseau sur le marché, fait au
japon, avec lames de carbone-stainless.
Coupe de cuir jusqu'à 13 oz. D'une
longévité exceptionnelle. Confortable. /
*One of the best shears on the market,
made in japan, with high quality blades,
long lasting with maximum ease of
handling.*



MR-1025
Pierre ronde Osborne à aiguiser
Arkansas pour outils. / *Arkansas carving
tool stones by Osborne.*



Cuillères à modeler. 3 modèles
différents. / *Modeling tool spoon.
3 different models.*

MJ-60010
MJ-60011
MJ-60012



MR-799
Arrache talon C.S Osborne manche
jaune. / *Yellow heel pinch Osborne.*



MR-65
Marteau à soulier Osborne /
Shoes hammer Osborne



MR-471
Outil Osborne pour modeler le cuir. /
Osborne Modeler leather tool.



MR-66
Marteau à cordonnier Osborne. /
Hammer for repair shoe shop Osborne.



VZ-71
Recharge de stylo à cuir/ *Refill for
leather pen.*

PLANCHE ET MAILLETS / PLANK AND MALLETS



MR-planche

Planche Osborne 10"x10" en vinyle/ plastique robuste. Absorbe les coupures et assure longue vie à nos matoirs./

Osborne vinyl plastic cutting pad 10" x 10". Helps to absorb cuts and keep your tools in good condition.



Planche à découper de polypropylène rouge (recyclée). / *Poly cutting board (recycled).*

Grandeur assorties – *Different sizes*



3446-00

Maillet de bois Tandy/ *Tandy Wooden Mallet.*



MJ-29454

Maillet en caoutchouc 6 oz./ *Rubber mallet Hammer 6 oz.*



MR-396-2

Maillet Osborne en caoutchouc blanc. / *White rubber Osborne mallet.*



MR-392 + poids (ex: MR-392-2 pour 2 lbs) Maillet nylon Osborne. / *Osborne Maul in nylon.*

1,5 lbs, 2 lbs, 3lbs, 4 lbs.



MR-496

Maillet Osborne en polymère 8 onces / *8 oz. Osborne Polymer mallet.*



MJ-60001

Maillet babiche de bison large 42mm./ *Bison Raw hide mallet large 42mm.*



MR-3952R

Marteau babiche professionnel Osborne 2 onces. Idéal pour tous les outils professionnels dont les matoirs robustes à oeillets. Têtes interchangeables. À utiliser avec la planche Osborne (MR-Planche).

2 oz Osborne professional rawhide mallet. Perfect for Osborne professional tools as the grommet setter. To use with MR-Planche



MR-196-3

Maillet professionnel en babiche #3 / Osborne / *Osborne Rawhide mallet size 3.*



MR-393 + poids (ex: MR-393-2 pour 2 lbs)

Maillet Osborne robuste avec manche en bois et bout de babiche. / *Rawhide Osborne mallet with wood handle.*

2 lbs, 3lbs, 4 lbs ou/or 6 lbs.





DESROCHERS

CUIRS · LEATHERS

— 1981 —

www.cuirsdessrochers.com

1857, rue Savoie, Plessisville (Québec) G6L 1L1
819-362-8622 • 1-800-362-8622
cuirsdessrochers@cuirsdessrochers.com